



CST08P06S P-Ch 60V Fast Switching MOSFETs

100% EAS Guaranteed
 Green Device Available
 Super Low Gate Charge
 Excellent CdV/dt effect decline
 Advanced high cell density Trench technology

CST08P06S Product Summary



BVDSS	RDSON	ID
-60V	70mΩ	-8.0A

CST08P06S Description

The CST08P06S is the high cell density trenched P-ch MOSFETs, which provide excellent RDSON and gate charge for most of the synchronous buck converter applications. The CST08P06S meet the RoHS and Green Product requirement, 100% EAS guaranteed with full function reliability approved.

CST08P06S SOP8 Pin Configuration

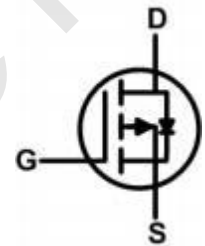
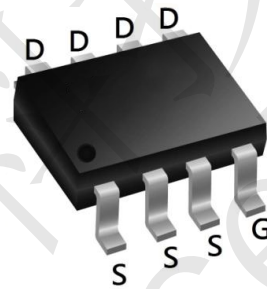

CST08P06S Absolute Maximum Ratings

Symbol	Parameter	Rating	Units
V _{DS}	Drain-Source Voltage	-60	V
V _{GS}	Gate-Source Voltage	±20	V
I _D @T _A =25°C	Continuous Drain Current, V _{GS} @ -10V ¹	-8.0	A
I _D @T _A =70°C	Continuous Drain Current, V _{GS} @ -10V ¹	-6.2	A
I _{DM}	Pulsed Drain Current ²	-16.2	A
EAS	Single Pulse Avalanche Energy ³	69.7	mJ
I _{AS}	Avalanche Current	44.4	A
P _D @T _A =25°C	Total Power Dissipation ⁴	6.1	W
T _{STG}	Storage Temperature Range	-55 to 150	°C
T _J	Operating Junction Temperature Range	-55 to 150	°C

CST08P06S Thermal Data

Symbol	Parameter	Typ.	Max.	Unit
R _{θJA}	Thermal Resistance Junction-Ambient ¹	---	85	°C/ W
R _{θJC}	Thermal Resistance Junction-Case ¹	---	36	°C/ W



CST08P06S P-Ch 60V Fast Switching MOSFETs

CST08P06S Electrical Characteristics ($T_J=25\text{ C}$, unless otherwise noted)

Symbol	Parameter	Conditions	Min.	Typ.	Max.	Unit
BV_{DSS}	Drain-Source Breakdown Voltage	$V_{GS}=0V, I_D=-250\mu A$	-60	---	---	V
$\Delta BV_{DSS}/\Delta T_J$	BV_{DSS} Temperature Coefficient	Reference to 25 C , $I_D=-1\text{ mA}$	---	-0.03	---	V/ C
$R_{DS(ON)}$	Static Drain-Source On-Resistance ²	$V_{GS}=-10V, I_D=-3A$	---	70	90	$m\Omega$
		$V_{GS}=-4.5V, I_D=-2A$	---	90	115	
$V_{GS(th)}$	Gate Threshold Voltage	$V_{GS}=V_{DS}, I_D=-250\mu A$	-1.2	---	-2.5	V
$\Delta V_{GS(th)}$	$V_{GS(th)}$ Temperature Coefficient		---	4.56	---	mV/ C
I_{DSS}	Drain-Source Leakage Current	$V_{DS}=-48V, V_{GS}=0V, T_J=25\text{ C}$	---	---	1	μA
		$V_{DS}=-48V, V_{GS}=0V, T_J=55\text{ C}$	---	---	5	
I_{GSS}	Gate-Source Leakage Current	$V_{GS}=\pm 20V, V_{DS}=0V$	---	---	± 100	nA
g_{fs}	Forward Transconductance	$V_{DS}=-5V, I_D=-3A$	---	8.7	---	S
R_g	Gate Resistance	$V_{DS}=0V, V_{GS}=0V, f=1\text{ MHz}$	---	15	---	Ω
Q_g	Total Gate Charge (-4.5V)	$V_{DS}=-48V, V_{GS}=-4.5V, I_D=-3A$	---	11.8	---	nC
Q_{gs}	Gate-Source Charge		---	1.9	---	
Q_{gd}	Gate-Drain Charge		---	6.5	---	
$T_{d(on)}$	Turn-On Delay Time	$V_{DD}=-15V, V_{GS}=-10V, R_G=3.3\Omega, I_D=-1A$	---	8.8	---	ns
T_r	Rise Time		---	19.6	---	
$T_{d(off)}$	Turn-Off Delay Time		---	47.2	---	
T_f	Fall Time		---	9.6	---	
C_{iss}	Input Capacitance	$V_{DS}=-15V, V_{GS}=0V, f=1\text{ MHz}$	---	1080	---	pF
C_{oss}	Output Capacitance		---	73	---	
C_{rss}	Reverse Transfer Capacitance		---	50	---	

CST08P06S Diode Characteristics

Symbol	Parameter	Conditions	Min.	Typ.	Max.	Unit
I_S	Continuous Source Current ^{1,5}	$V_G=V_D=0V$, Force Current	---	---	-8.0	A
I_{SM}	Pulsed Source Current ^{2,5}		---	---	-16.2	A
V_{SD}	Diode Forward Voltage ²	$V_{GS}=0V, I_S=-1A, T_J=25\text{ C}$	---	---	-1.2	V

Note :

- The data tested by surface mounted on a 1 inch² FR-4 board with 20Z copper.
- The data tested by pulsed, pulse width $\leq 300\mu s$, duty cycle $\leq 2\%$
- The EAS data shows Max. rating. The test condition is $V_{DD}=-25V, V_{GS}=-10V, L=0.1\text{ mH}, I_{AS}=-24.4A$
- The power dissipation is limited by 150C junction temperature
- The data is theoretically the same as I_D and I_{DM} , in real applications, should be limited by total power dissipation.



CST08P06S P-Ch 60V Fast Switching MOSFETs

CST08P06S Typical Characteristics

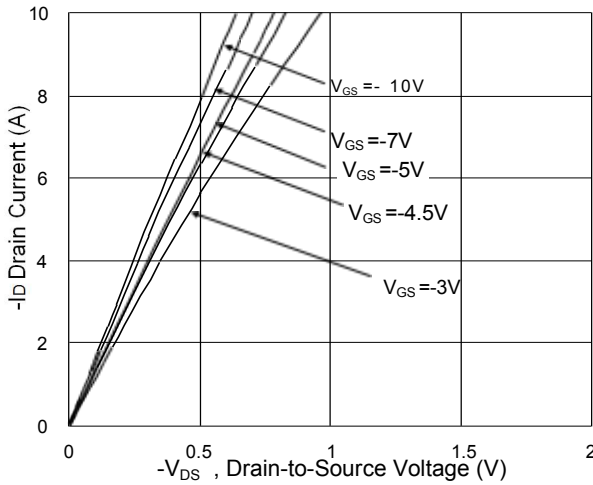

Fig. 1 Typical Output Characteristics

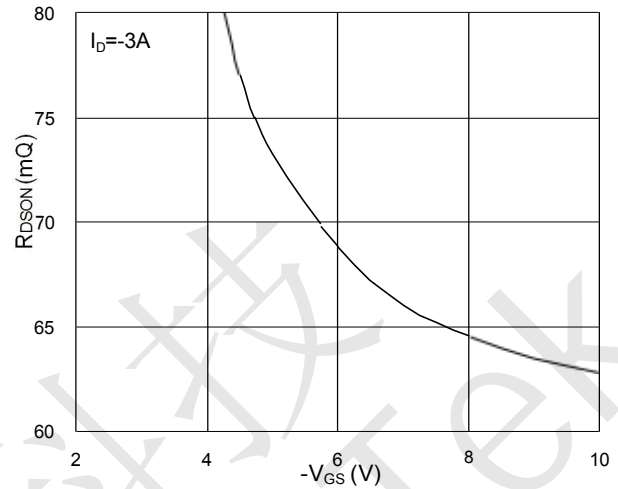

Fig. 2 On-Resistance v.s Gate-Source

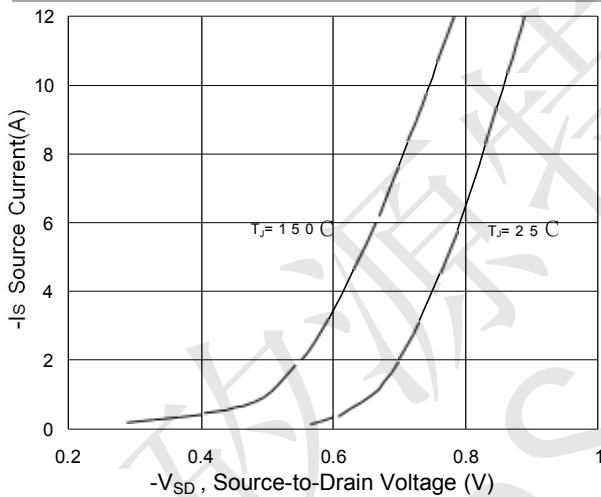

Fig. 3 Forward Characteristics of Reverse

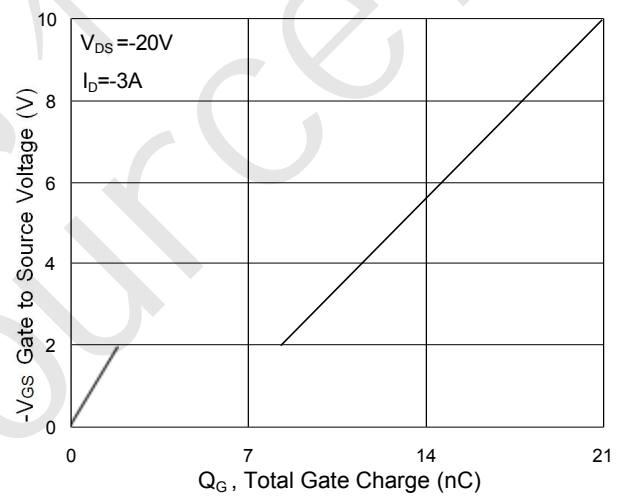

Fig. 4 Gate-Charge Characteristics

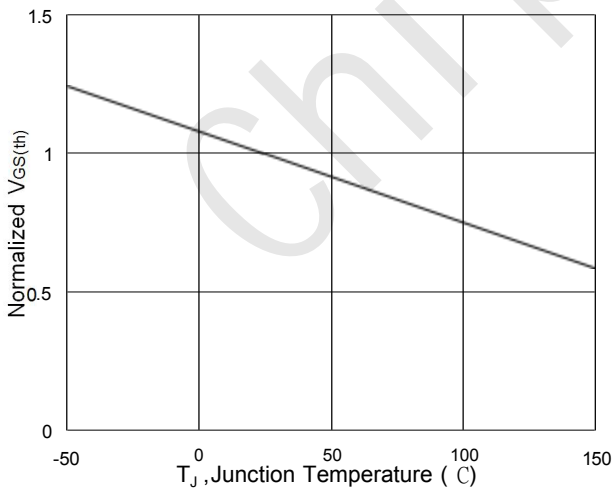

Fig. 5 Normalized $V_{GS(th)}$ vs. T_J

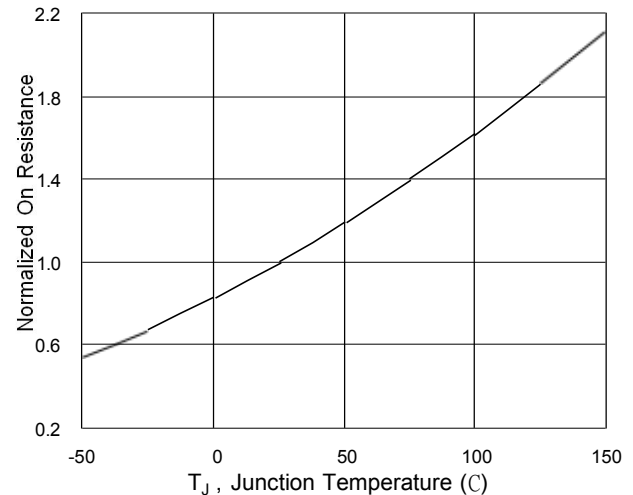

Fig. 6 Normalized $R_{DS(on)}$ vs. T_J



CST08P06S P-Ch 60V Fast Switching MOSFETs

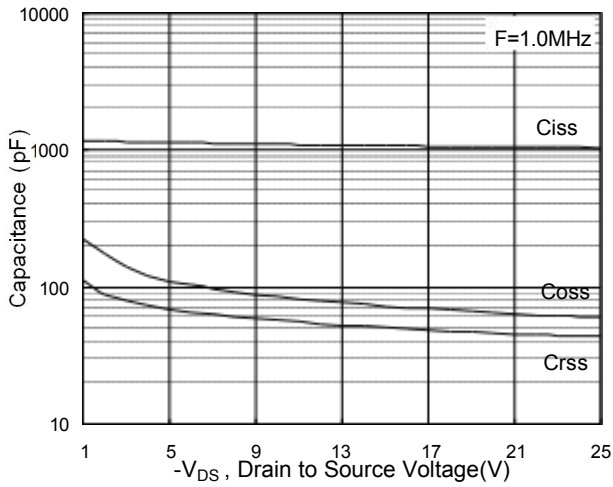

Fig. 7 Capacitance

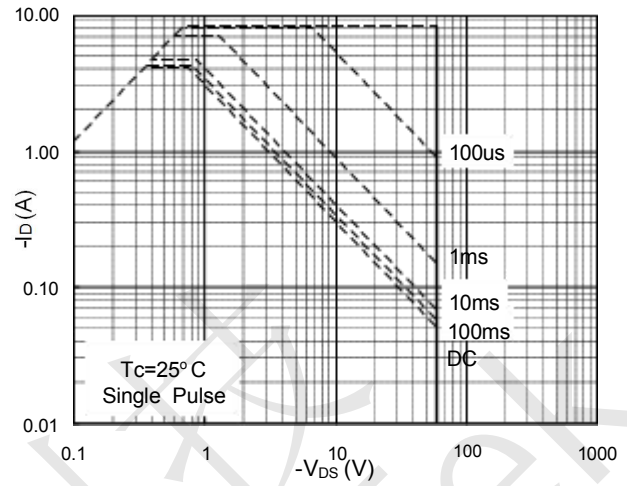

Fig. 8 Safe Operating Area

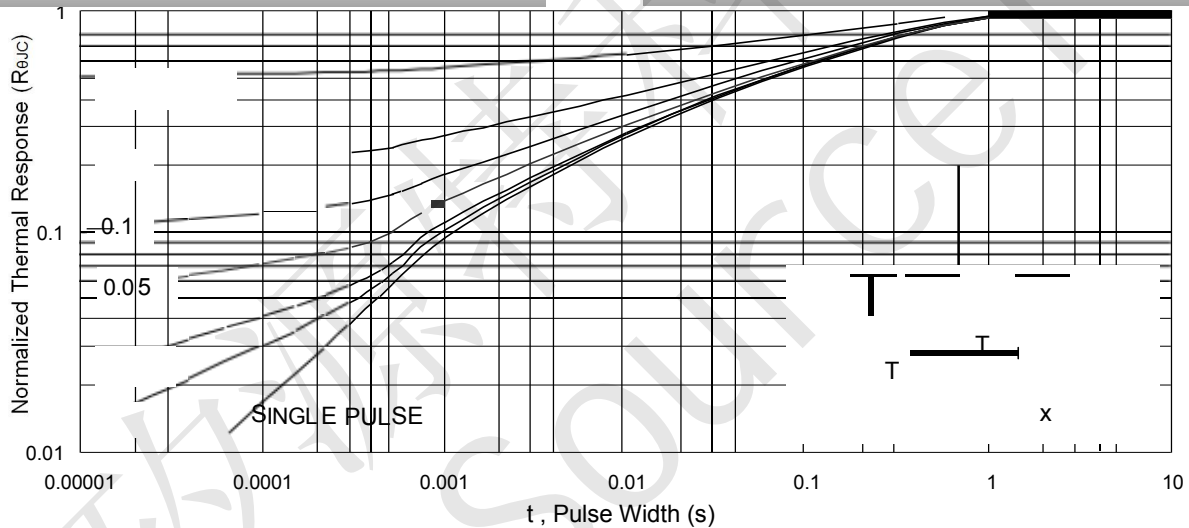

Fig. 9 Normalized Maximum Transient Thermal Impedance

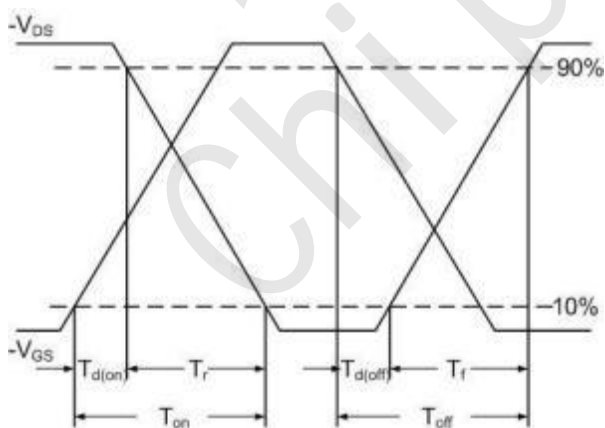

Fig. 10 Switching Time Waveform

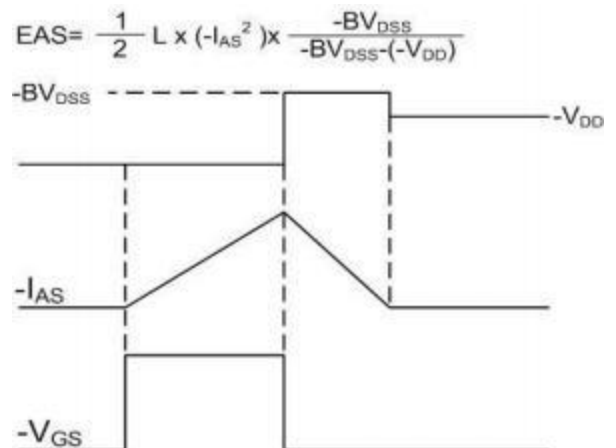
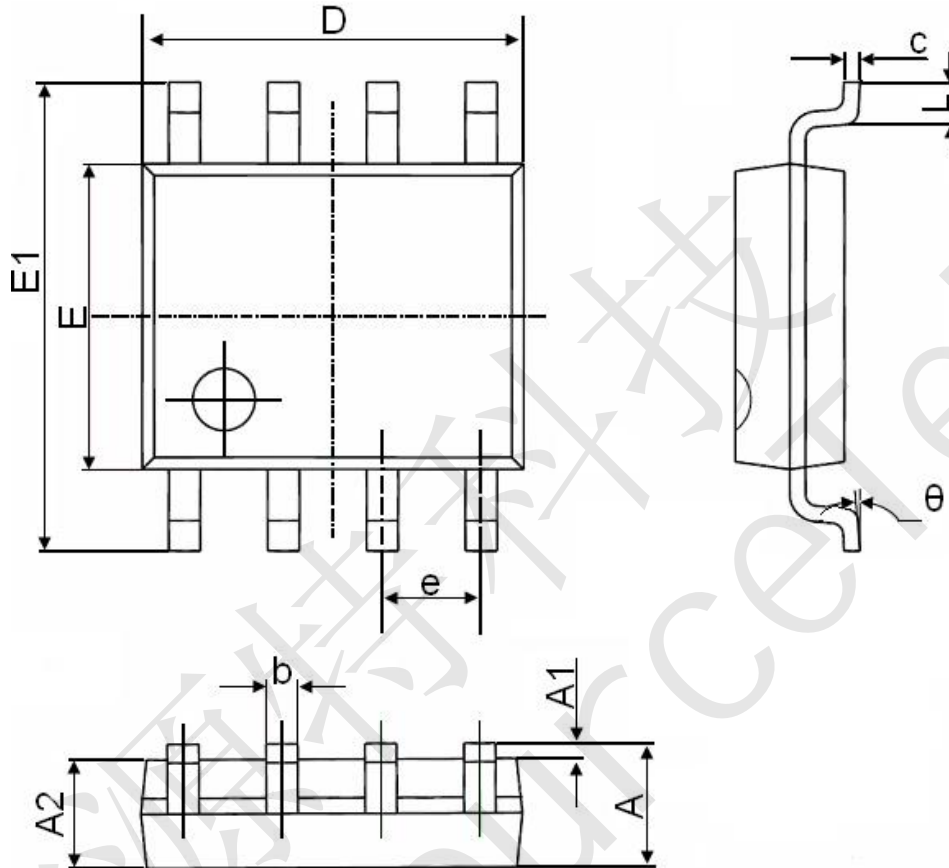

Fig. 11 Unclamped Inductive Waveform



CST08P06S SOP-8 Package Information



Symbol	Dimensions In Millimeters		Dimensions In Inches	
	Min.	Max.	Min.	Max.
A	1.350	1.750	0.053	0.069
A1	0.100	0.250	0.004	0.010
A2	1.350	1.550	0.053	0.061
b	0.330	0.510	0.013	0.020
c	0.170	0.250	0.006	0.010
D	4.700	5.100	0.185	0.200
E	3.800	4.000	0.150	0.157
E1	5.800	6.200	0.228	0.244
e	1.270(BSC)		0.050(BSC)	
L	0.400	1.270	0.016	0.050
θ	0°	8°	0°	8°