



CST50N06 N-Ch 60V Fast Switching MOSFETs

- ★ 100% EAS Guaranteed
- ★ Green Device Available
- ★ Super Low Gate Charge
- ★ Excellent CdV/dt effect decline
- ★ Advanced high cell density Trench technology

CST50N06 Product Summary

BVDSS	RDSON	ID
60V	12mΩ	50A

CST50N06 Description

The CST50N06 is the high performance complementary N-ch and P-ch MOSFETs with high cell density, which provide excellent RDSON and gate charge for most of the synchronous buck converter applications. The CST50N06 meet the RoHS and Green Product requirement 100% EAS guaranteed with full function reliability approved.

CST50N06 TO252 Pin Configuration

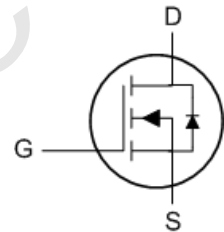
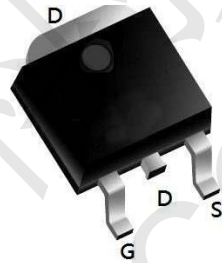

CST50N06 Absolute Maximum Ratings (TC=25°C unless otherwise specified)

Symbol	Parameter	Max.	Units	
V _{DSS}	Drain-Source Voltage	60	V	
V _{GSS}	Gate-Source Voltage	±20	V	
I _D	Continuous Drain Current	T _C = 25°C	50	A
		T _C = 100°C	33	A
I _{DM}	Pulsed Drain Current ^{note1}	200	A	
EAS	Single Pulsed Avalanche Energy ^{note2}	68	mJ	
P _D	Power Dissipation	T _C = 25°C	87.7	W
R _{θJC}	Thermal Resistance, Junction to Case	1.6	°C/W	
T _J , T _{STG}	Operating and Storage Temperature Range	-55 to +175	°C	



CST50N06 N-Ch 60V Fast Switching MOSFETs

CST50N06 Electrical Characteristics (T_J=25°C unless otherwise specified)

Symbol	Parameter	Test Condition	Min.	Typ.	Max.	Units
Off Characteristic						
V _{(BR)DSS}	Drain-Source Breakdown Voltage	V _{GS} =0V, I _D =250μA	60	-	-	V
I _{DSS}	Zero Gate Voltage Drain Current	V _{DS} =60V, V _{GS} =0V,	-	-	1.0	μA
I _{GSS}	Gate to Body Leakage Current	V _{DS} =0V, V _{GS} = ±20V	-	-	±100	nA
On Characteristics						
V _{GS(th)}	Gate Threshold Voltage	V _{DS} =V _{GS} , I _D =250μA	1.0	1.6	2.5	V
R _{DS(on)}	Static Drain-Source on-Resistance <small>note3</small>	V _{GS} =10V, I _D =30A	-	12	17	mΩ
		V _{GS} =4.5V, I _D =20A	-	16	25	
Dynamic Characteristics						
C _{iss}	Input Capacitance	V _{DS} =25V, V _{GS} =0V, f=1.0MHz	-	2900	-	pF
C _{oss}	Output Capacitance		-	140	-	pF
C _{rss}	Reverse Transfer Capacitance		-	120	-	pF
Q _g	Total Gate Charge	V _{DS} =30V, I _D =30A, V _{GS} =10V	-	50	-	nC
Q _{gs}	Gate-Source Charge		-	6	-	nC
Q _{gd}	Gate-Drain("Miller") Charge		-	15	-	nC
Switching Characteristics						
t _{d(on)}	Turn-on Delay Time	V _{DS} =30V, I _D =30A, R _G =1.8Ω, V _{GS} =10V	-	7.4	-	ns
t _r	Turn-on Rise Time		-	5.1	-	ns
t _{d(off)}	Turn-off Delay Time		-	28.2	-	ns
t _f	Turn-off Fall Time		-	5.5	-	ns
Drain-Source Diode Characteristics and Maximum Ratings						
I _S	Maximum Continuous Drain to Source Diode Forward Current		-	-	50	A
I _{SM}	Maximum Pulsed Drain to Source Diode Forward Current		-	-	200	A
V _{SD}	Drain to Source Diode Forward Voltage	V _{GS} =0V, I _S =30A	-	-	1.2	V
t _{rr}	Body Diode Reverse Recovery Time	I _F =30A, di/dt=100A/μs	-	28	-	ns
Q _{rr}	Body Diode Reverse Recovery Charge		-	40	-	nC

Notes:1. Repetitive Rating: Pulse Width Limited by Maximum Junction Temperature

2. EAS condition : T_J=25°C, V_{DD}=30V, V_G=10V, L=0.5mH, R_G=25Ω, I_{AS}=16A

3. Pulse Test: Pulse Width≤300μs, Duty Cycle≤0.5%



CST50N06 Typical Performance Characteristics

Figure 1: Output Characteristics

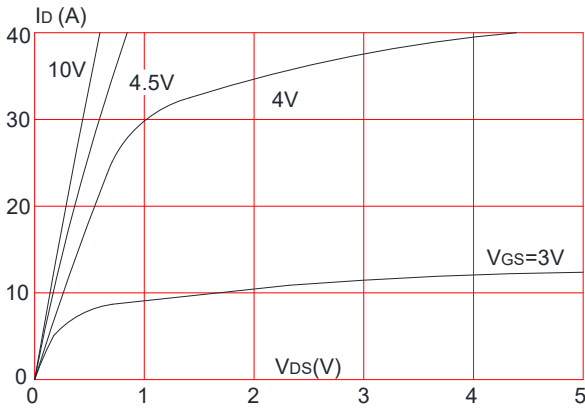

Figure 2: Typical Transfer Characteristics

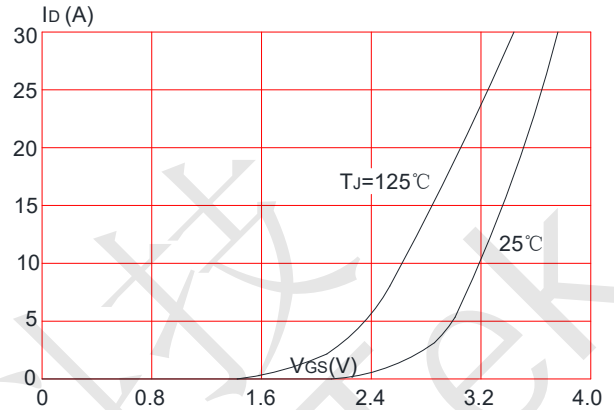

Figure 3: On-resistance vs. Drain Current

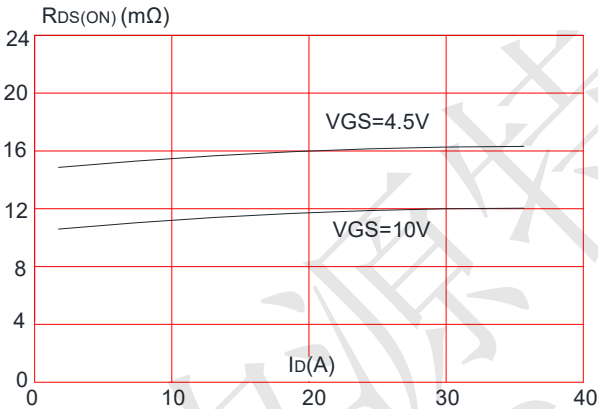

Figure 4: Body Diode Characteristics

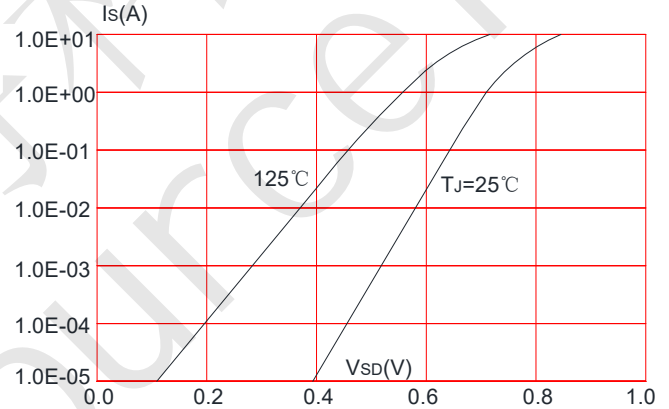

Figure 5: Gate Charge Characteristics

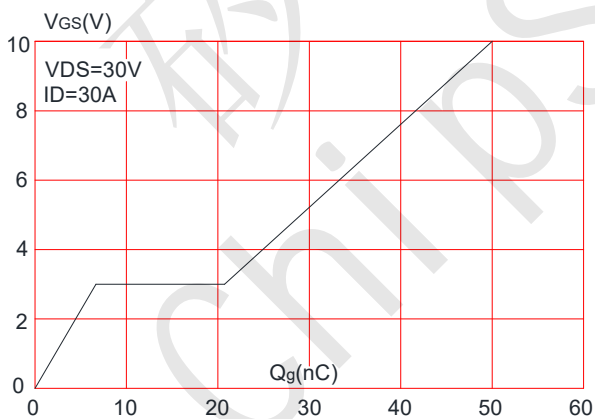
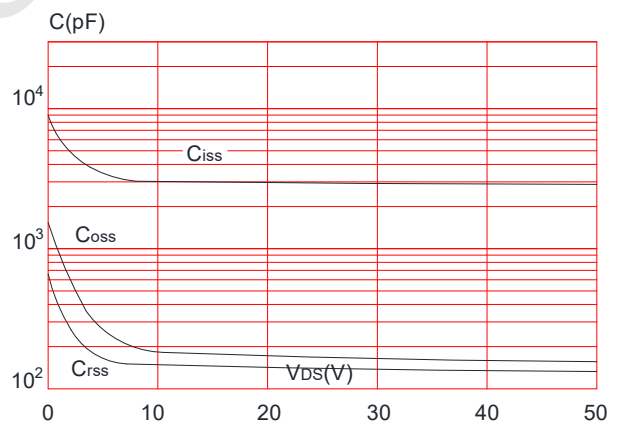

Figure 6: Capacitance Characteristics





CST50N06 N-Ch 60V Fast Switching MOSFETs

Figure 7: Normalized Breakdown Voltage vs. Junction Temperature

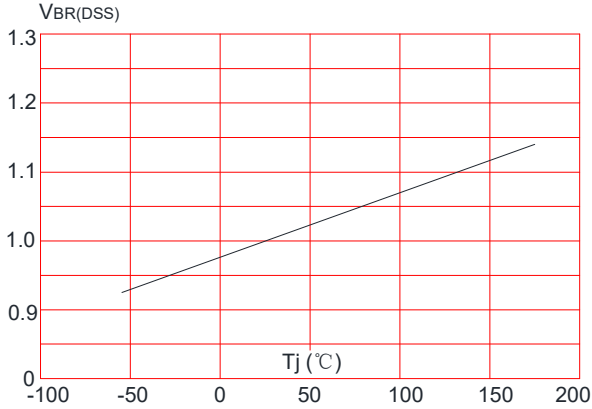

Figure 8: Normalized on Resistance vs. Junction Temperature

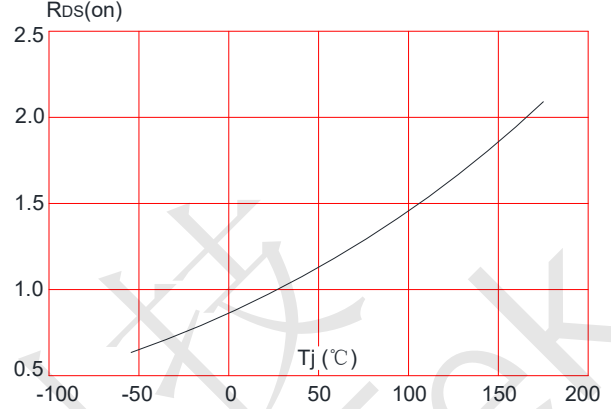

Figure 9: Maximum Safe Operating Area

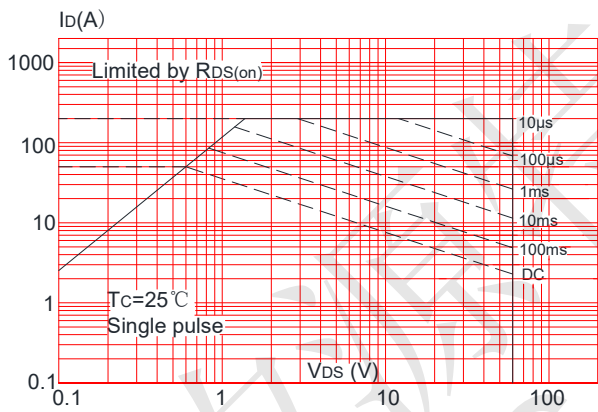

Figure 10: Maximum Continuous Drain Current vs. Case Temperature

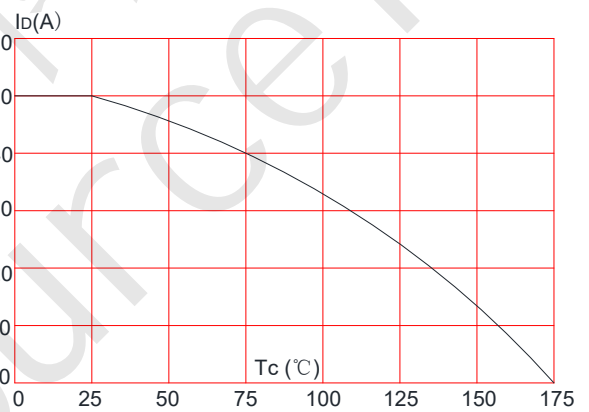
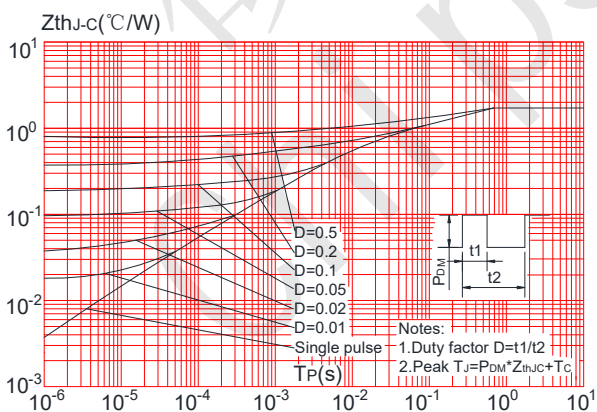

Figure.11: Maximum Effective Transient Thermal Impedance, Junction-to-Case





CST50N06 N-Ch 60V Fast Switching MOSFETs

CST50N06 Package Mechanical Data-TO-252-4R

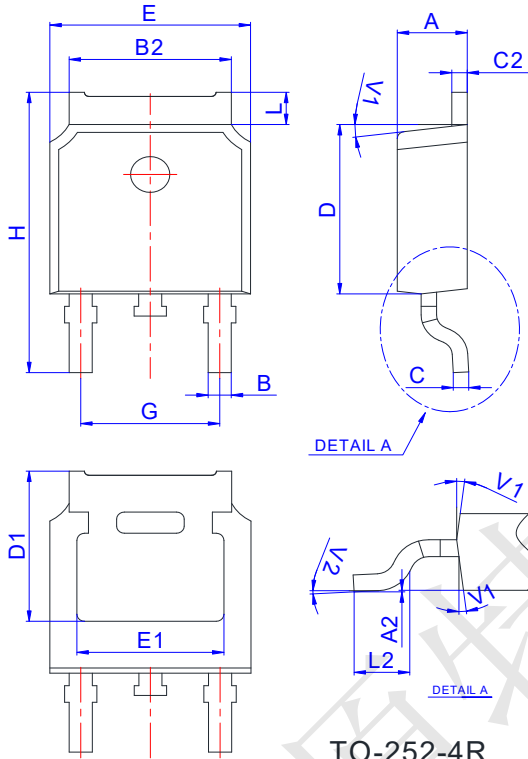

Ref.	Dimensions					
	Millimeters			Inches		
	Min.	Typ.	Max.	Min.	Typ.	Max.
A	2.10		2.50	0.083		0.098
A2	0		0.10	0		0.004
B	0.66		0.86	0.026		0.034
B2	5.18		5.48	0.202		0.216
C	0.40		0.60	0.016		0.024
C2	0.44		0.58	0.017		0.023
D	5.90		6.30	0.232		0.248
D1	5.30REF			0.209REF		
E	6.40		6.80	0.252		0.268
E1	4.63			0.182		
G	4.47		4.67	0.176		0.184
H	9.50		10.70	0.374		0.421
L	1.09		1.21	0.043		0.048
L2	1.35		1.65	0.053		0.065
V1		7°			7°	
V2	0°		6°	0°		6°

TO-252-4R

CST50N06 Reel Specification-TO-252-4R

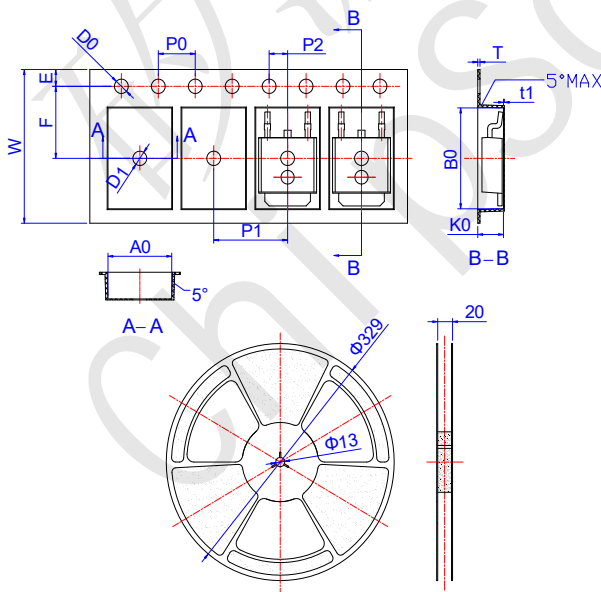

Ref.	Dimensions					
	Millimeters			Inches		
	Min.	Typ.	Max.	Min.	Typ.	Max.
W	15.90	16.00	16.10	0.626	0.630	0.634
E	1.65	1.75	1.85	0.065	0.069	0.073
F	7.40	7.50	7.60	0.291	0.295	0.299
D0	1.40	1.50	1.60	0.055	0.059	0.063
D1	1.40	1.50	1.60	0.055	0.059	0.063
P0	3.90	4.00	4.10	0.154	0.157	0.161
P1	7.90	8.00	8.10	0.311	0.315	0.319
P2	1.90	2.00	2.10	0.075	0.079	0.083
A0	6.85	6.90	7.00	0.270	0.271	0.276
B0	10.45	10.50	10.60	0.411	0.413	0.417
K0	2.68	2.78	2.88	0.105	0.109	0.113
T	0.24		0.27	0.009		0.011
t1	0.10			0.004		
10P0	39.80	40.00	40.20	1.567	1.575	1.583