



Dual N-Channel Enhancement Mode Power MOSFET **MX8205**

MX8205 DESCRIPTION

The MX8205 uses advanced trench technology to provide excellent $R_{DS(ON)}$ and low gate charge. It can be used in a wide variety of applications.

MX8205 GENERAL FEATURES

- $V_{DS}=20V$, $I_D=6A$
 $R_{DS(ON)}(Typ.)=20m\Omega$ @ $V_{GS}=4.5V$
 $R_{DS(ON)}(Typ.)=21m\Omega$ @ $V_{GS}=3.8V$
 $R_{DS(ON)}(Typ.)=26m\Omega$ @ $V_{GS}=2.5V$
- High Power and current handling capability
- Lead free product is acquired
- Surface Mount Package

MX8205 APPLICATION

- Battery protection
- Load switch

MX8205 PINOUT

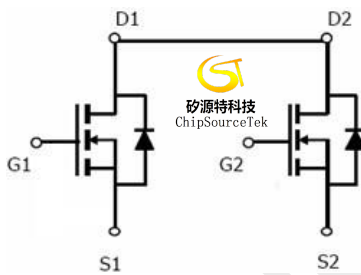

Schematic diagram

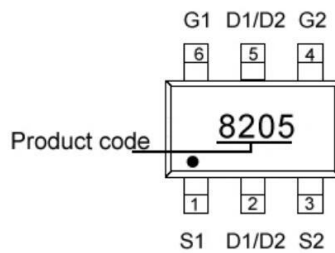

Marking and Pin Assignment

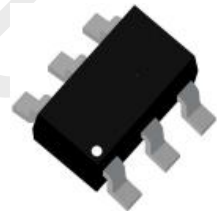

SOT23-6 top view

MX8205 ORDERING INFORMATION

Part Number	Storage Temperature	Package	Devices Per Reel
MX8205	-55°C to 150°C	SOT23-6	3000

MX8205 ABSOLUTE MAXIMUM RATINGS ($T_A=25^\circ C$ unless otherwise noted)

Parameter	Symbol	Limit	Unit
Drain-Source Voltage	V_{DS}	20	V
Gate-Source Voltage	V_{GS}	± 12	V
Drain Current-Continuous	I_D	6	A
Drain Current-Pulsed ^(Note1)	I_{DM}	24	A
Maximum Power Dissipation	P_D	1.5	W
Operating Junction and Storage Temperature Range	T_J, T_{STG}	-55 to 150	$^\circ C$

MX8205 ERMAL RESISTANCE

Thermal Resistance, Junction-to-Ambient ^(Note2)	$R_{\theta JA}$	83	$^\circ C/W$
--	-----------------	----	--------------

Note 1. Repetitive Rating: Pulse width limited by maximum junction temperature.

Note 2. Surface Mounted on FR4 Board, $t \leq 10$ sec.



MX8205 ELECTRICAL CHARACTERISTICS (T_A=25°C unless otherwise noted)

Parameter	Symbol	Conditions	Min	Typ	Max	Unit
-----------	--------	------------	-----	-----	-----	------

Off Characteristics

Drain-Source Breakdown Voltage	BV _{DSS}	V _{GS} =0V, I _D =250μA	20	-	-	V
Zero Gate Voltage Drain Current	I _{DSS}	V _{DS} =20V, V _{GS} =0V	-	-	1	μA
Gate-Body Leakage Current	I _{GSS}	V _{GS} =±12V, V _{DS} =0V	-	-	±100	nA

On Characteristics (Note 3)

Gate Threshold Voltage	V _{GS(th)}	V _{DS} =V _{GS} , I _D =250μA	0.45	0.7	1.2	V
Drain-Source On-State Resistance	R _{DS(ON)}	V _{GS} =4.5V, I _D =4.5A	18	20	24	mΩ
		V _{GS} =3.8V, I _D =4A	19	21	26	mΩ
		V _{GS} =2.5V, I _D =3.5A	24	26	32	mΩ
Forward Transconductance	g _{FS}	V _{DS} =5V, I _D =4.5A	-	10	-	S

Dynamic Characteristics (Note4)

Input Capacitance	C _{iss}	V _{DS} =10V, V _{GS} =0V, F=1.0MHz	-	600	-	pF
Output Capacitance	C _{oss}		-	330	-	pF
Reverse Transfer Capacitance (Note4)	C _{rss}		-	140	-	pF

Switching Characteristics (Note4)

Turn-on Delay Time	t _{d(on)}	V _{DD} =10V, I _D =1A V _{GS} =4.5V, R _G =6Ω	-	10	-	nS
Turn-on Rise Time	t _r		-	11	-	nS
Turn-Off Delay Time	t _{d(off)}		-	35	-	nS
Turn-Off Fall Time	t _f		-	30	-	nS
Total Gate Charge	Q _g	V _{DS} =10V, I _D =6A, V _{GS} =4.5V	-	10	-	nC
Gate-Source Charge	Q _{gs}		-	1.5	-	nC
Gate-Drain Charge	Q _{gd}		-	2.3	-	nC

Drain-Source Diode Characteristics

Diode Forward Voltage (Note 3)	V _{SD}	V _{GS} =0V, I _S =1A	-	-	1.2	V
Diode Forward Current (Note 2)	I _S		-	-	6	A

Note 2. Surface Mounted on FR4 Board, t ≤ 10 sec.

Note 3. Pulse Test: Pulse Width ≤ 300μs, Duty Cycle ≤ 2%.

Note 4. Guaranteed by design, not subject to product.



MX8205 TYPICAL ELECTRICAL AND THERMAL CHARACTERISTICS

Figure 1. Switching Test Circuit

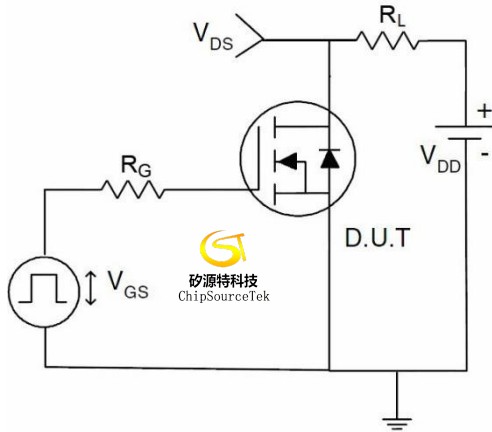

Figure 2. Switching Waveform

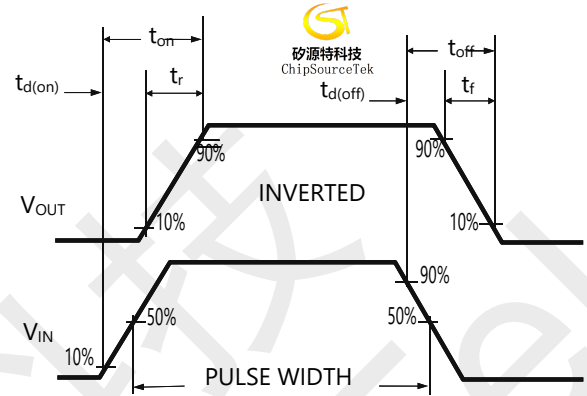

Figure 3. Power Dissipation

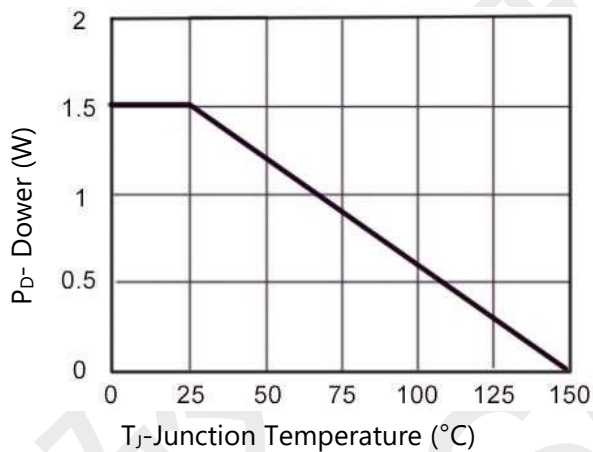

Figure 4. Drain Current

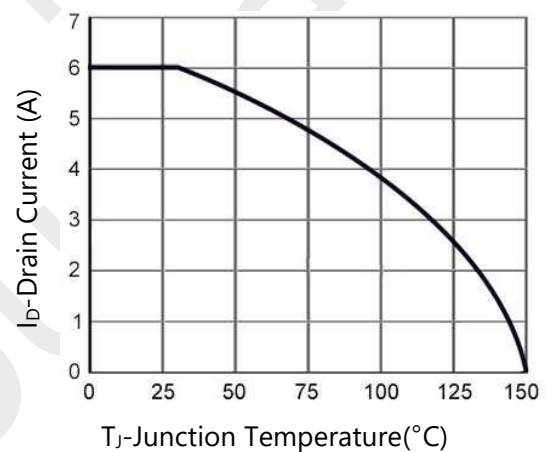

Figure 5. Output Characteristics

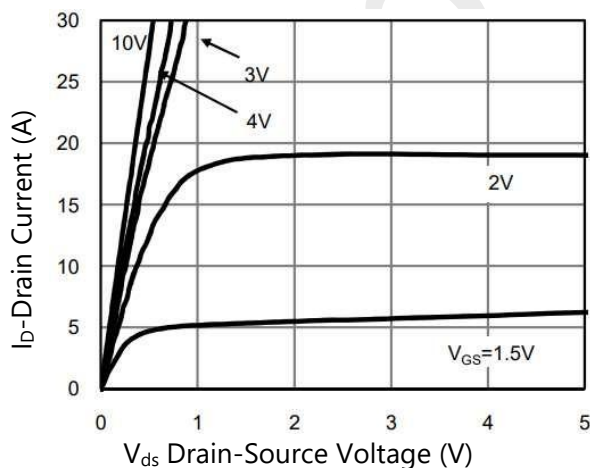
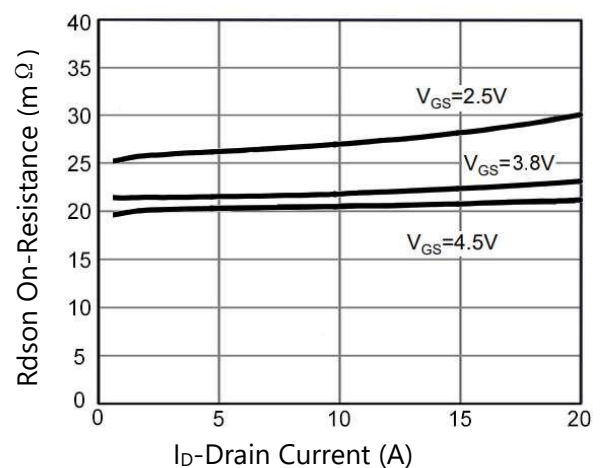

Figure 6. R_{dson} vs Drain Current





MX8205 TYPICAL ELECTRICAL AND THERMAL CHARACTERISTICS

Figure 7. Transfer Characteristics

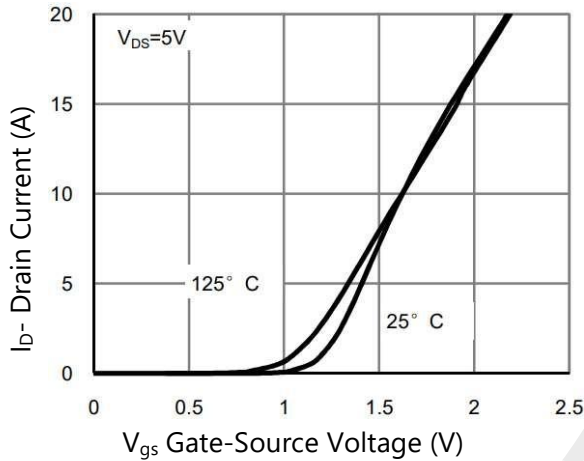

Figure 8. R_{dson} vs Junction Temperature

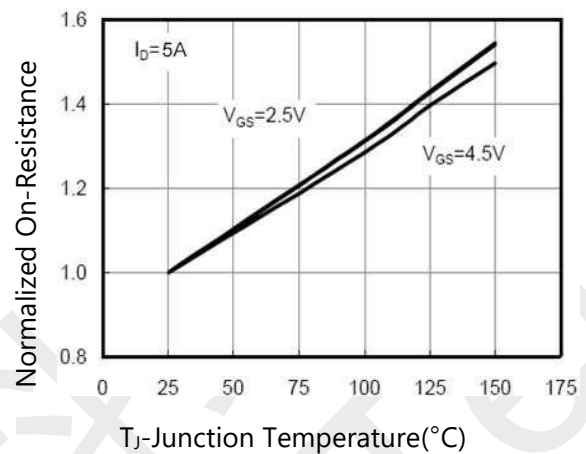

Figure 9. R_{dson} vs V_{gs}

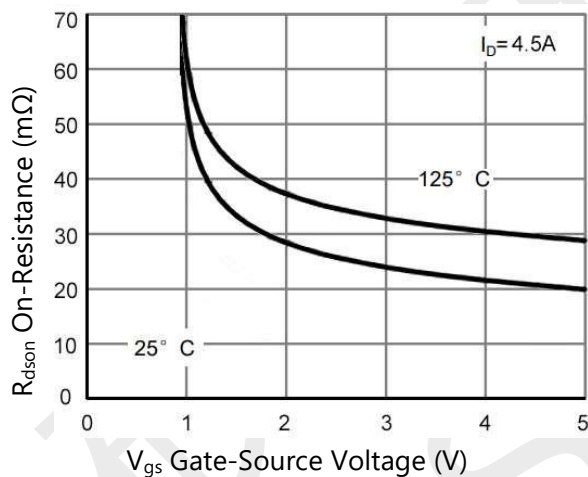

Figure 10. Capacitance vs V_{ds}

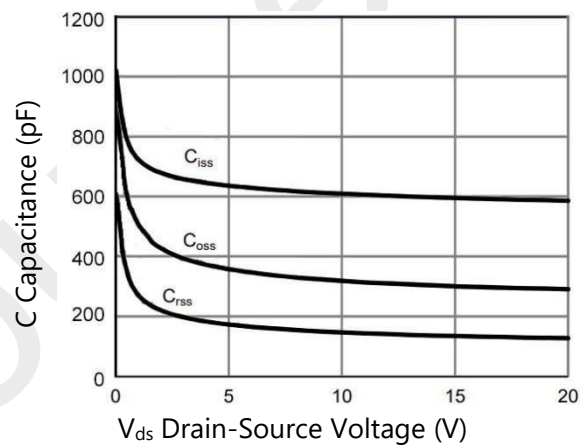

Figure 11. Gate Charge

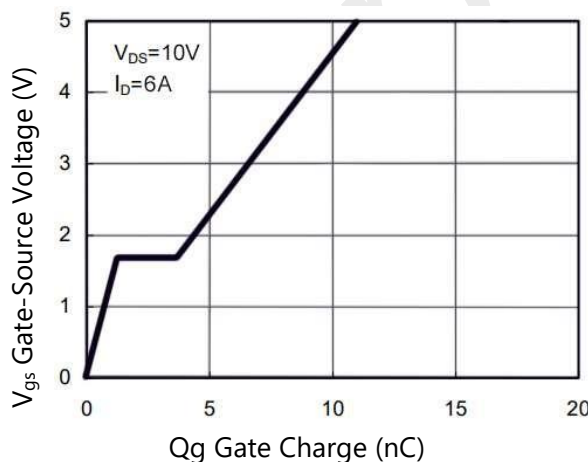
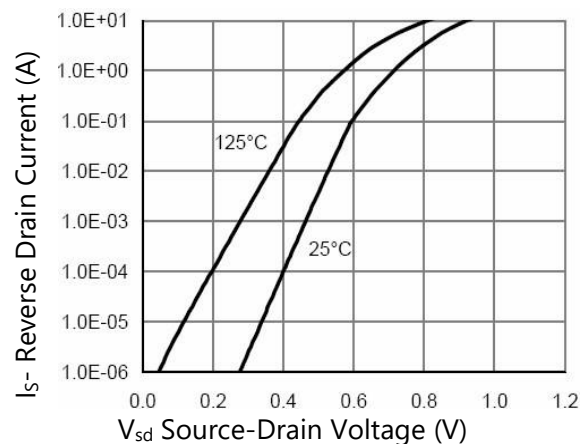

Figure 12. Source-Drain Diode Forward





MX8205 TYPICAL ELECTRICAL AND THERMAL CHARACTERISTICS

Figure 13. Safe Operation Area

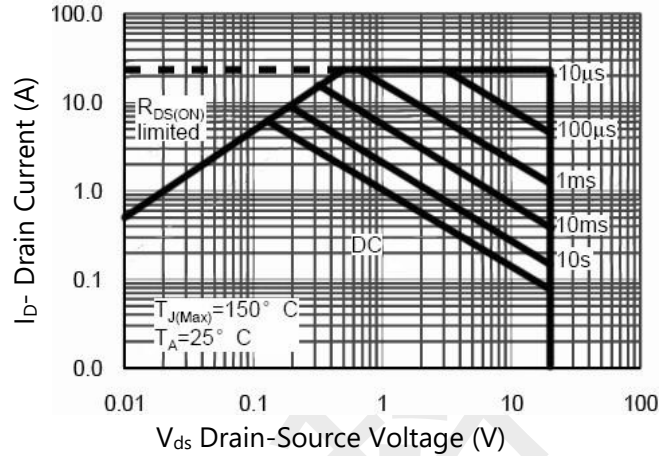
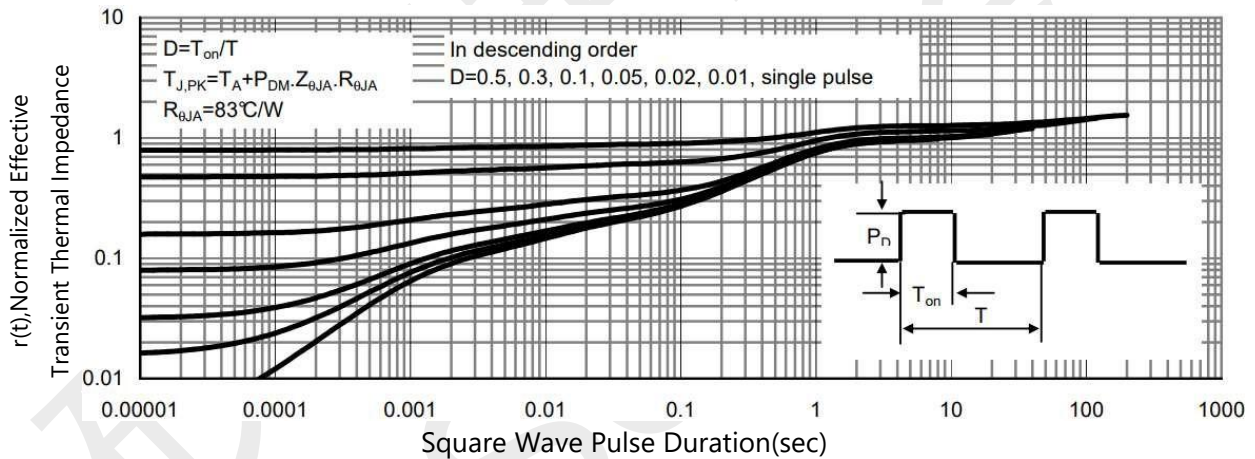

Figure 14. Normalized Maximum Transient Thermal Impedance





MX8205 PACKAGE INFORMATION

SOT23-6

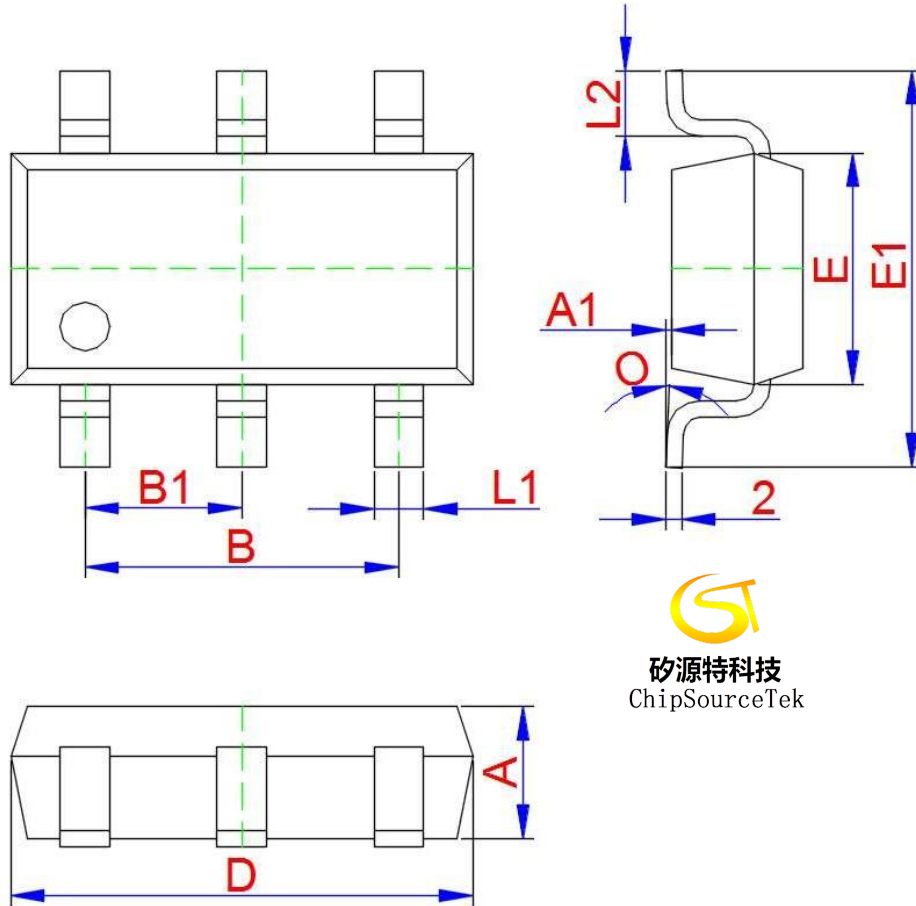

Symbol	Dimensions In Millimeters		
	Min.	Typ.	Max.
A	1.050	1.100	1.150
A1	0.000	0.050	0.100
L1	0.300	0.400	0.500
C	0.100	0.150	0.200
D	2.820	2.920	3.020
E	1.500	1.600	1.700
E1	2.650	2.800	2.950
B	1.800	1.900	2.000
B1	0.950 TYP.		
L2	0.300	0.450	0.600
O	0°	4°	8°