

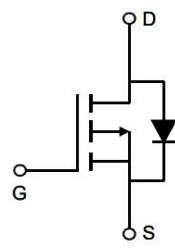

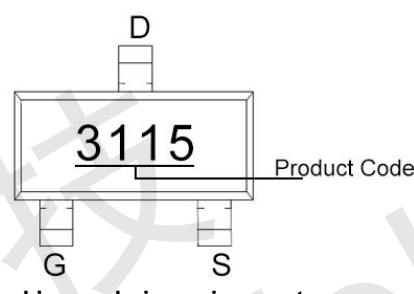

**P-Channel Enhancement Mode Power MOSFET**

<p><b>Description</b></p> <p>The PE3115 uses advanced trench technology to provide excellent <math>R_{DS(ON)}</math> and low gate charge. It can be used in a wide variety of applications.</p> <p><b>General Features</b></p> <ul style="list-style-type: none"> <li><math>V_{DS} = -30V, I_D = -5.5A</math></li> <li><math>R_{DS(ON)} &lt; 27m\Omega @ V_{GS}=-10V</math></li> <li><math>R_{DS(ON)} &lt; 31m\Omega @ V_{GS}=-4.5V</math></li> <li><math>R_{DS(ON)} &lt; 42m\Omega @ V_{GS}=-2.5V</math></li> <li>High Power and current handling capability</li> <li>Lead free product is acquired</li> <li>Surface Mount Package</li> </ul> <p><b>Application</b></p> <ul style="list-style-type: none"> <li>PWM applications</li> <li>Load switch</li> <li>Power management</li> </ul>	 <p style="text-align: center;"><b>Schematic diagram</b></p>  <p style="text-align: center;"><b>Marking and pin assignment</b></p>  <p style="text-align: center;"><b>SOT-23-3L</b></p>
--	---

**Absolute Maximum Ratings (TA=25°C unless otherwise noted)**

Parameter	Symbol	Rating	Unit
Drain-Source Voltage	$V_{DS}$	-30	V
Gate-Source Voltage	$V_{GS}$	±12	V
Drain Current-Continuous	$I_D$	-5.5	A
Pulsed Drain Current (Note 1)	$I_{DM}$	-30	A
Maximum Power Dissipation	$P_D$	1.5	W
Operating Junction and Storage Temperature Range	$T_J, T_{STG}$	-55 To 150	°C

**Thermal Characteristic**

Thermal Resistance, Junction-to-Ambient (Note 2)	$R_{\theta JA}$	83	°C/W
--	-----------------	----	------



**Electrical Characteristics (TA=25°C unless otherwise noted)**

Parameter	Symbol	Condition	Min	Typ	Max	Unit
<b>Off Characteristics</b>						
Drain-Source Breakdown Voltage	$BV_{DSS}$	$V_{GS}=0V, I_D=-250\mu A$	-30	-	-	V
Zero Gate Voltage Drain Current	$I_{DSS}$	$V_{DS}=-30V, V_{GS}=0V$	-	-	1	$\mu A$
Gate-Body Leakage Current	$I_{GSS}$	$V_{GS}=\pm 12V, V_{DS}=0V$	-	-	$\pm 100$	nA
<b>On Characteristics (Note 3)</b>						
Gate Threshold Voltage	$V_{GS(th)}$	$V_{DS}=V_{GS}, I_D=-250\mu A$	-0.7	-1	-1.3	V
Drain-Source On-State Resistance	$R_{DS(on)}$	$V_{GS}=-10V, I_D=-4.2A$	-	22	27	m $\Omega$
		$V_{GS}=-4.5V, I_D=-4A$	-	25	31	m $\Omega$
		$V_{GS}=-2.5V, I_D=-1A$	-	32	42	m $\Omega$
Forward Transconductance	$g_{FS}$	$V_{DS}=-10V, I_D=-4.2A$	-	22	-	S
<b>Dynamic Characteristics (Note 4)</b>						
Input Capacitance	$C_{iss}$	$V_{DS}=-15V, V_{GS}=0V,$ $F=1.0MHz$	-	1530	-	pF
Output Capacitance	$C_{oss}$		-	165	-	pF
Reverse Transfer Capacitance (Note 4)	$C_{rss}$		-	130	-	pF
<b>Switching Characteristics</b>						
Turn-on Delay Time	$t_{d(on)}$	$V_{DS}=-15V, I_D=-3.2A,$ $R_L=1\Omega,$ $V_{GS}=-10V, R_G=3\Omega$	-	12.6	-	nS
Turn-on Rise Time	$t_r$		-	5.2	-	nS
Turn-Off Delay Time	$t_{d(off)}$		-	54	-	nS
Turn-Off Fall Time	$t_f$		-	21.4	-	nS
Total Gate Charge	$Q_g$	$V_{DS}=-15V, I_D=-4A,$ $V_{GS}=-10V$	-	13	-	nC
Gate-Source Charge	$Q_{gs}$		-	2.4	-	nC
Gate-Drain Charge	$Q_{gd}$		-	5.5	-	nC
<b>Drain-Source Diode Characteristics</b>						
Diode Forward Voltage (Note 3)	$V_{SD}$	$V_{GS}=0V, I_S=-1A$	-	-	-1.2	V
Diode Forward Current (Note 2)	$I_S$		-	-	-4	A

**Notes:**

1. Repetitive Rating: Pulse width limited by maximum junction temperature.
2. Surface Mounted on FR4 Board,  $t \leq 10$  sec.
3. Pulse Test: Pulse Width  $\leq 300\mu s$ , Duty Cycle  $\leq 2\%$ .
4. Guaranteed by design, not subject to product.



### Typical Electrical and Thermal Characteristics

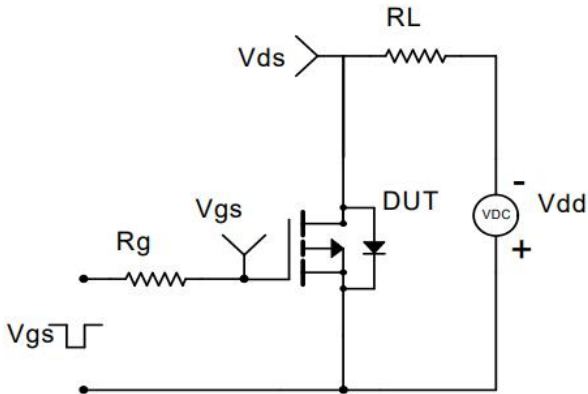

Figure 1 Switching Test Circuit

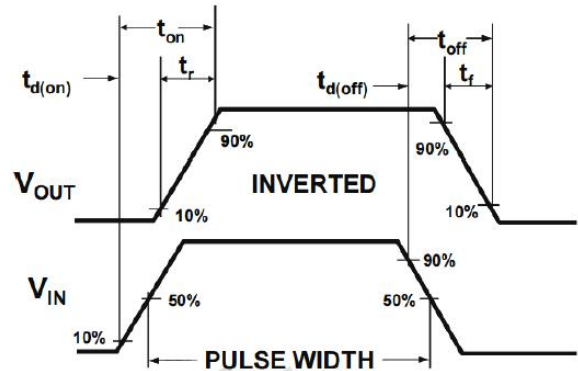

Figure 2 Switching Waveform

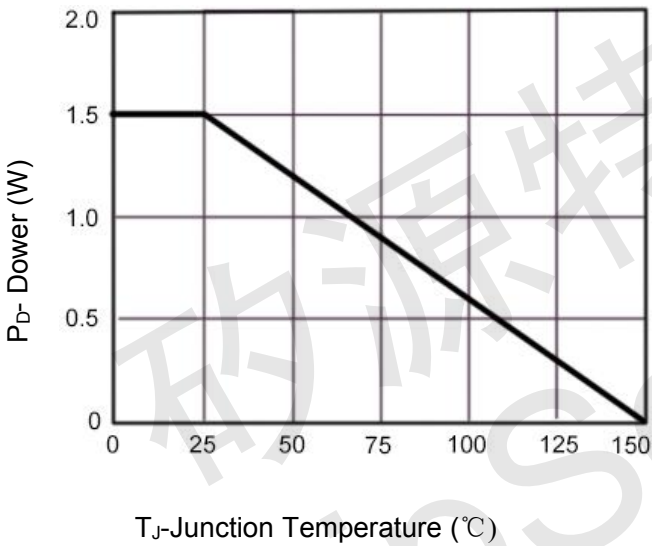

Figure 3 Power De-rating

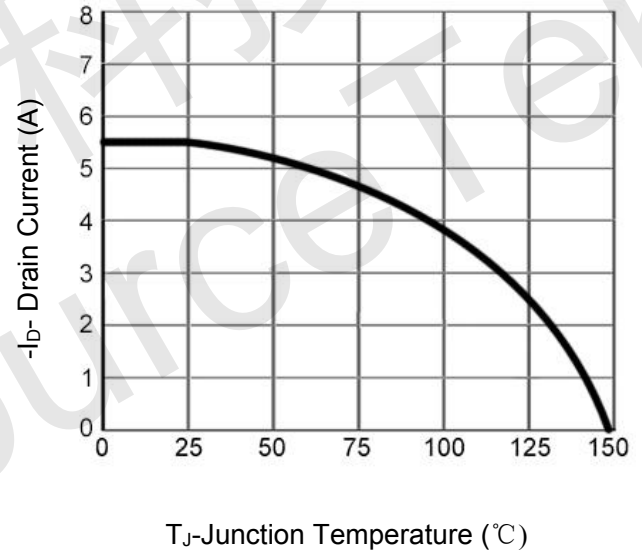

Figure 4 Drain Current

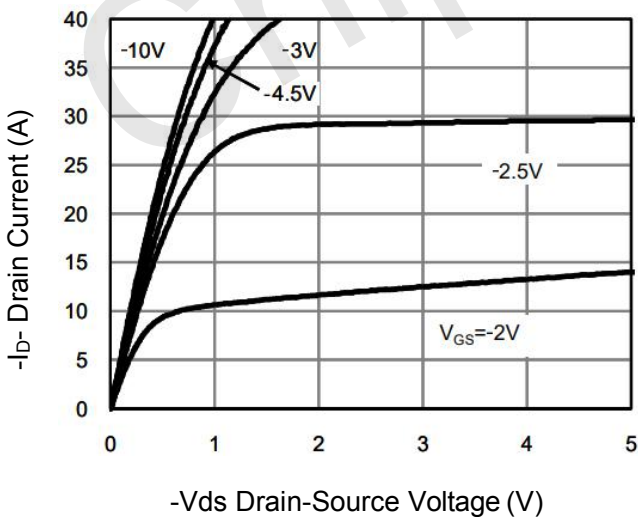

Figure 5 Output Characteristics

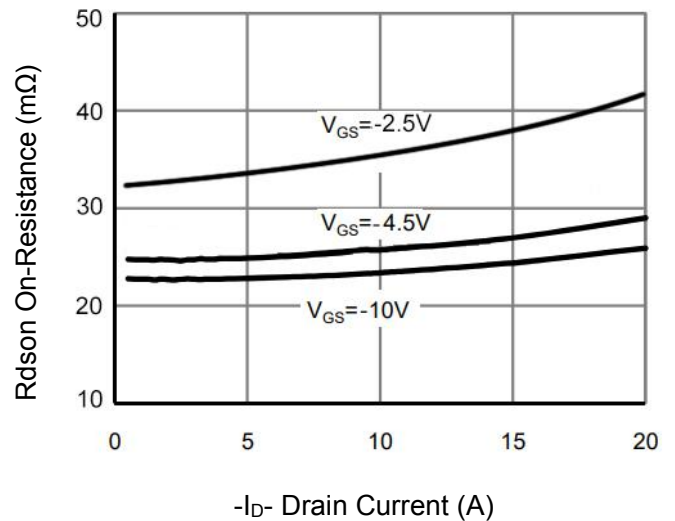

Figure 6 Rdson vs Drain Current

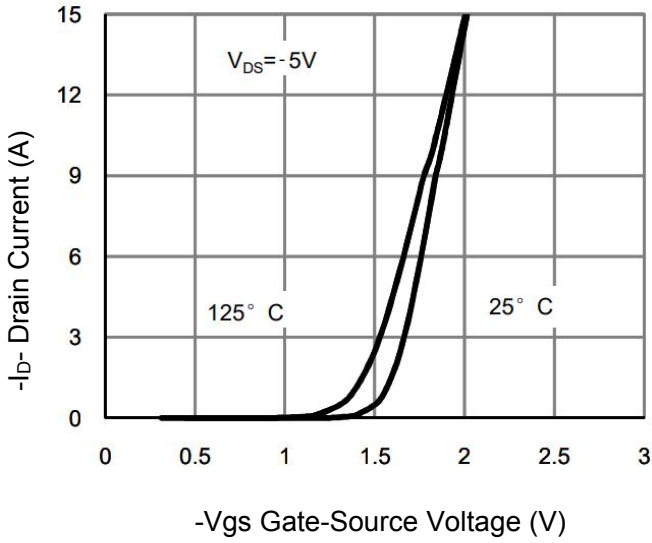

Figure 7 Transfer Characteristics

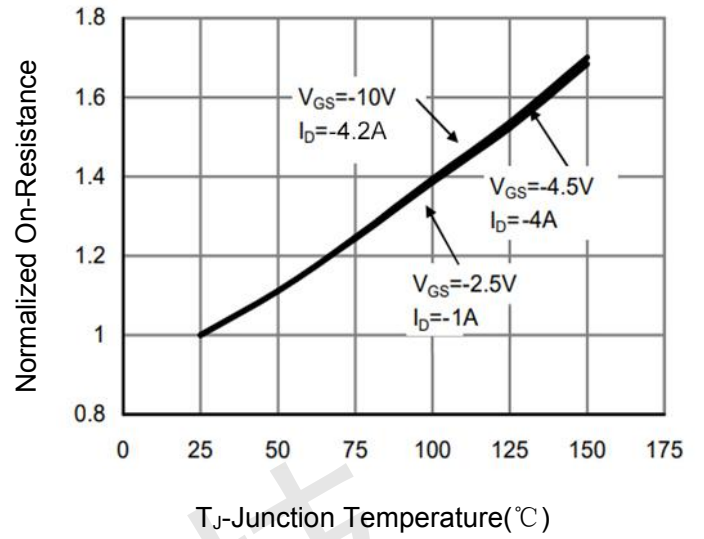

Figure 8 Rdson vs Junction Temperature

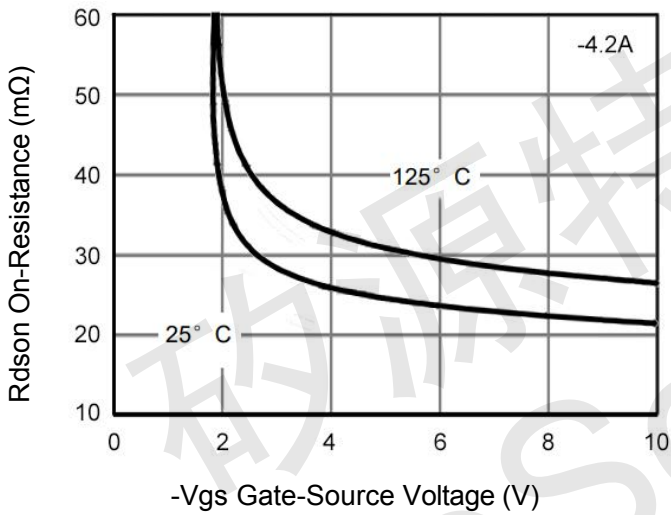

Figure 9 Rdson vs Vgs

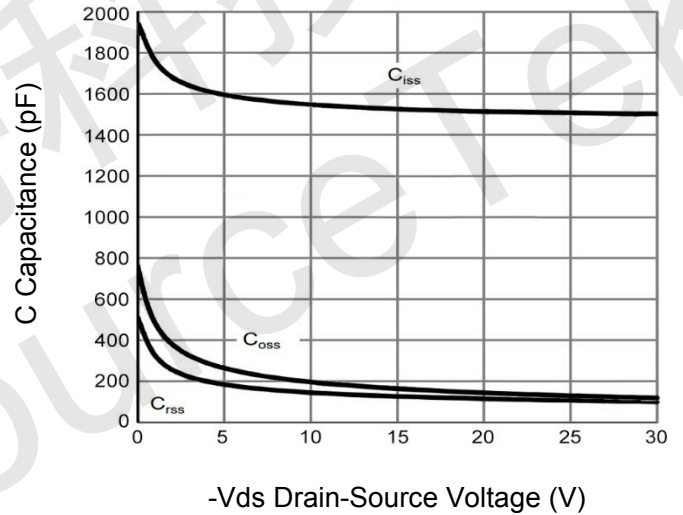

Figure 10 Capacitance vs Vds

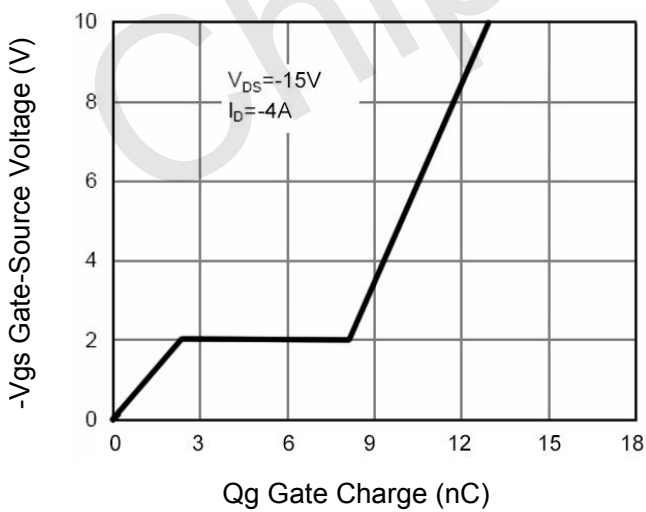

Figure 11 Gate Charge

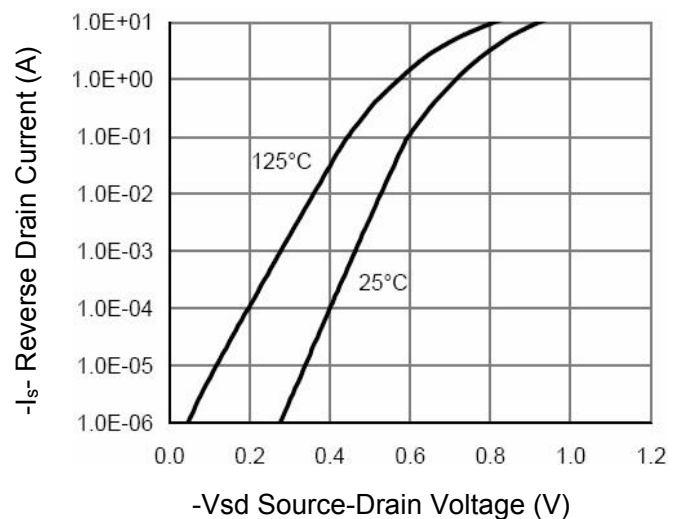

Figure 12 Source- Drain Diode Forward

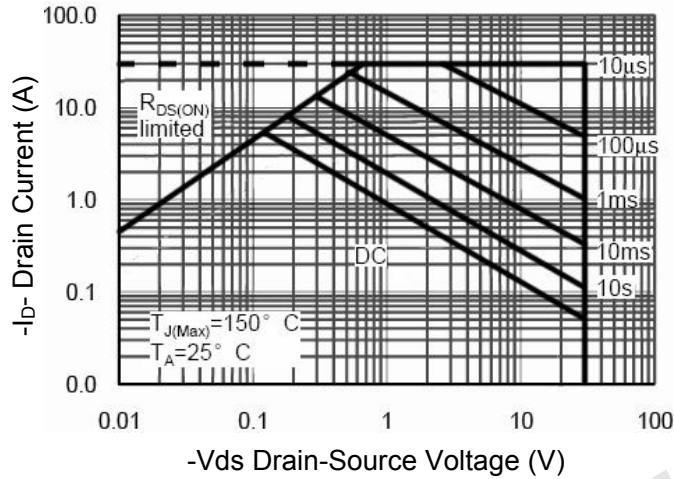

Figure 13 Safe Operation Area

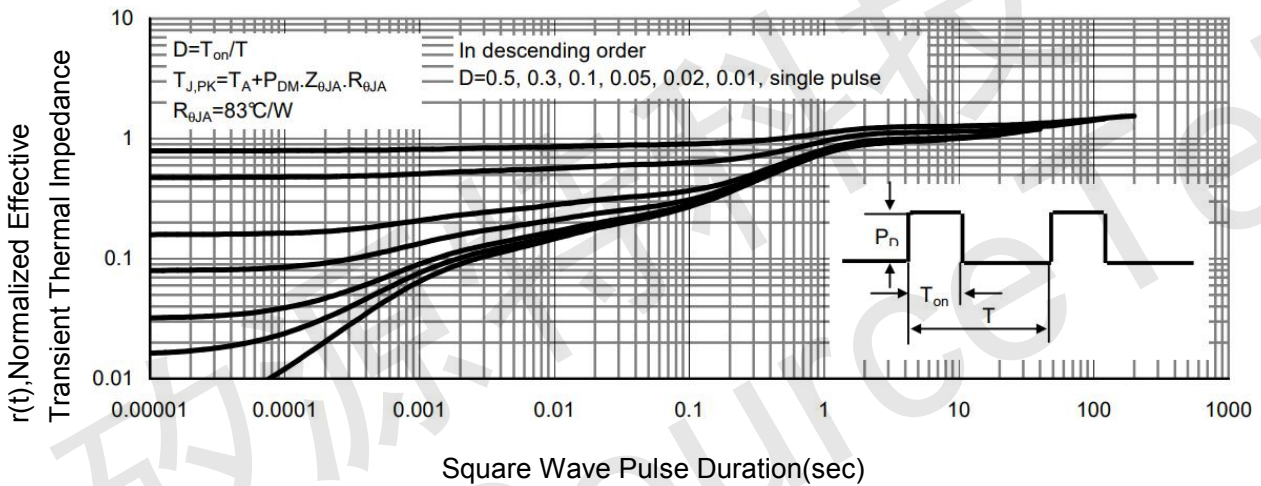
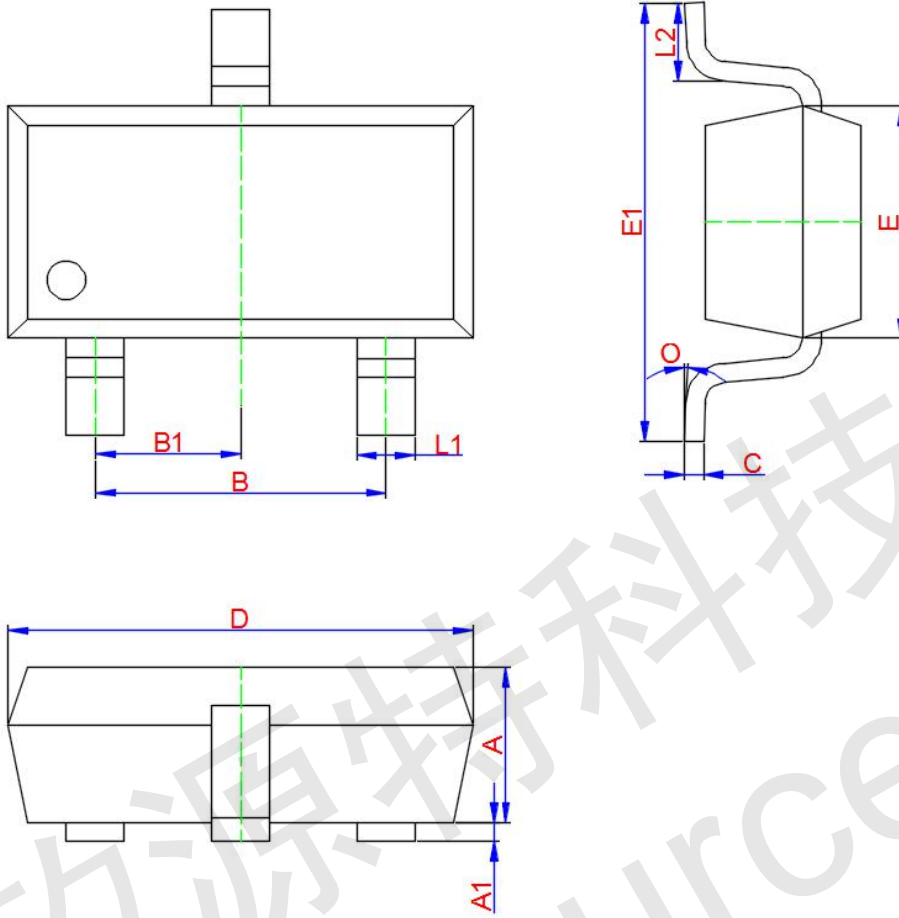

Figure 14 Normalized Maximum Transient Thermal Impedance



SOT-23-3L Package Information



Symbol	Dimensions In Millimeters		
	Min.	Typ.	Max.
A	1.050	1.100	1.150
A1	0.000	0.050	0.100
L1	0.300	0.400	0.500
C	0.100	0.150	0.200
D	2.820	2.920	3.020
E	1.500	1.600	1.700
E1	2.650	2.800	2.950
B	1.800	1.900	2.000
B1	0.950 TYP.		
L2	0.300	0.450	0.600
O	0°	4°	8°