



RY8630 60V 3A 500KHz Async Step-Down Regulator

RY8630 Features

- Wide 4.5V to 60V Operating Input Range
- 3A Continuous Output Current
- 500KHZ Switching Frequency
- Detectable Output Short Protection
- Programmable Output Over-Voltage Protection
- PSM Mode for High Efficiency in Light Load
- Low EMI Signature
- 150mΩ Internal Power MOSFETs
- Output Adjustable from 0.8V
- Internal Soft-Start
- Thermal Shutdown
- Available in ESOP8A, ESOP8B and ESOP8C Packages
- -40°C to +85°C Temperature Range

RY8630 Applications

- Automotive GPS
- Automotive Entertainment
- Power Supply for Linear Chargers
- Network Equipment

RY8630 General Description

The RY8630 is a current mode monolithic buck switching regulator. Operating with an input range of 4.5V~60V, it supplies 3A of continuous output current over a wide input-supply range with excellent load and line regulation. At light loads, the regulator operates in low frequency to maintain high efficiency and low output ripple. Current mode control provides tight load transient response. RY8630 achieves low EMI signature with well-controlled switching edges. Fault condition protection includes programmable output-voltage Protection, detectable output short protection, thermal shutdown and input under voltage lockout. The RY8630 is available in ESOP8A, ESOP8B and ESOP8C packages, which provide a compact solution with minimal external components.

RY8630 Typical Application Circuit

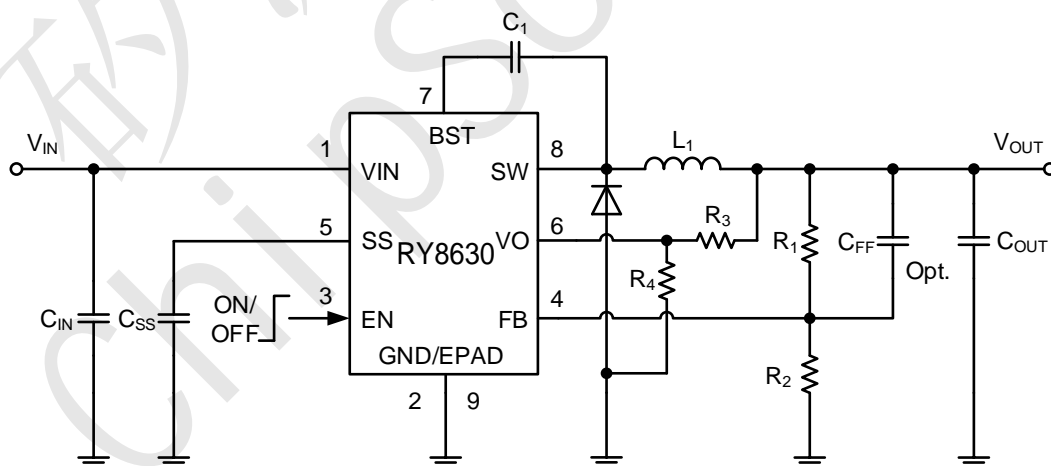

Typical RY8630AP8 Application Circuit



RY8630 60V 3A 500KHz Async Step-Down Regulator

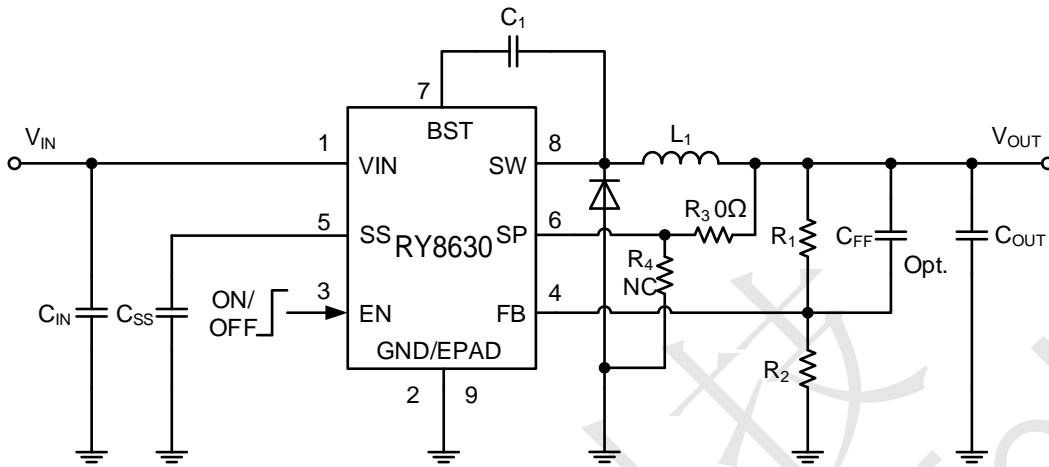

Typical RY8630BP8 Application Circuit

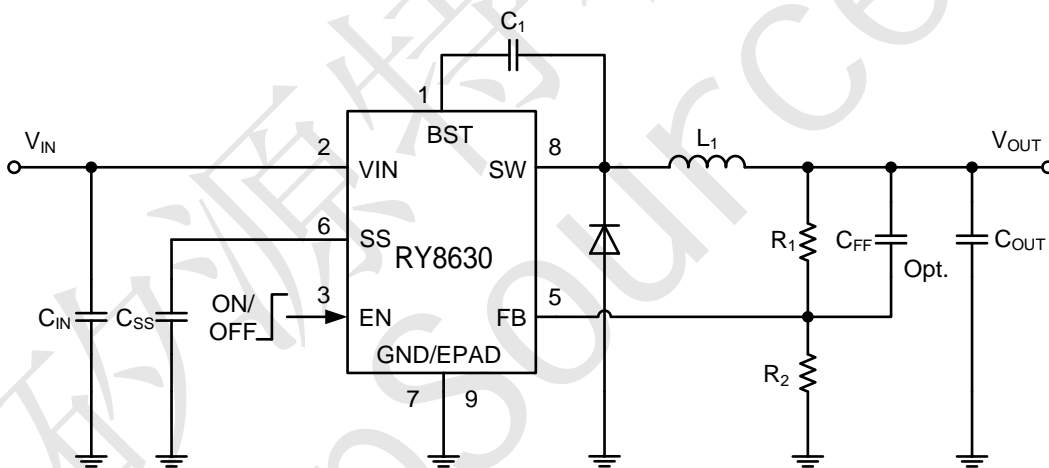

Typical RY8630CP8 Application Circuit



R Y8630 60V 3A 500KHz Async Step-Down Regulator

R Y8630 Package and Pin Description

Pin Configuration

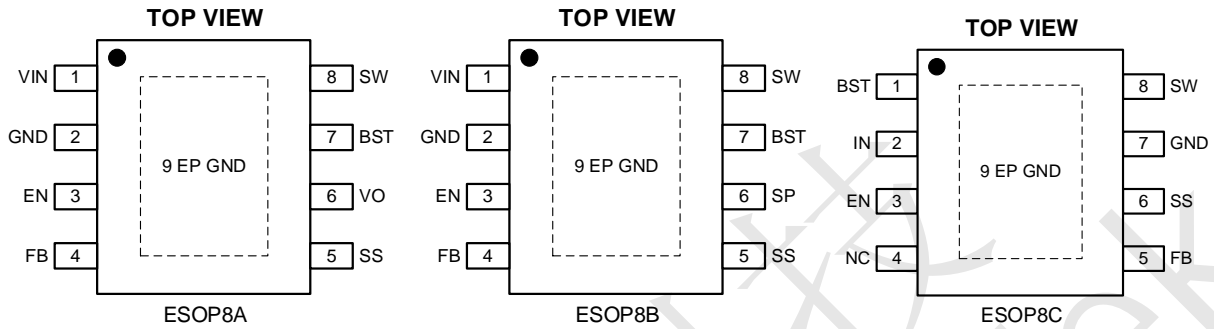

Top Marking: HeYLL (device code: He, Y=year code, LL= lot number code, ESOP8A)

Top Marking: HhYLL (device code: Hh, Y=year code, LL= lot number code, ESOP8B)

Top Marking: HiYLL (device code: Hi, Y=year code, LL= lot number code, ESOP8C)

Pin Description

Pin			Name	Function
ESOP8A	ESOP8B	ESOP8C		
1	1	2	VIN	Input Supply Pin. Must be locally bypassed.
2/9	2/9	7	GND/EPA D	Ground Pin. Connect exposed pad to GND plane for optimal thermal performance.
3	3	3	EN	Enable Input. Pull this pin below the specified threshold to shut the chip down. Pull it above the specified threshold enables the chip.
4	4	5	FB	Feedback Input. Connect a resistor divider to FB.
5	5	6	SS	Soft-Start. Connect to an external capacitor for Soft-Start.
6	NA	NA	VO	Output Over-Voltage Protection. Connect VO to the tap of an external resistor divider from VOUT to GND. The OVP reference is 0.9V.
NA	6	NA	SP	Output Short Protection. Connect SP to VOUT without any resistor.
7	7	1	BST	Bootstrap. Requires a capacitor to drive the power switch's gate above the supply voltage. Connect this capacitor between SW and BST pins to form a floating supply across the power switch driver. An on-chip regulator charges up the bootstrap capacitor. If the on-chip regulator is not strong enough, one optional diode can be connected from VIN or VOUT to charge the external boot-strap capacitor.



R_Y8630 60V 3A 500KHz Async Step-Down Regulator

8	8	8	SW	Power Switch Output. SW is the drain of the internal MOSFET switch. Connect the power inductor and output rectifier to SW.
NA	NA	4	NC	Not Connected.

R_Y8630 Order Information ⁽¹⁾

Marking	Part No.	Model	Description	Package	T/R Qty
He _Y LL	70301780	R _Y 8630AP8	R _Y 8630AP8 PSM Async Buck, 4.5-60V, 3A, 500KHz, VFB 0.8V, VO, ESOP8A	ESOP8A	3000PCS
Hh _Y LL	70301781	R _Y 8630BP8	R _Y 8630BP8 PSM Async Buck, 4.5-60V, 3A, 500KHz, VFB 0.8V, SP, ESOP8B	ESOP8B	3000PCS
Hi _Y LL	70301782	R _Y 8630CP8	R _Y 8630CP8 PSM Async Buck, 4.5-60V, 3A, 500KHz, VFB 0.8V, ESOP8C	ESOP8C	3000PCS

Note (1): All R_YCHIP parts are Pb-Free and adhere to the RoHS directive.



R Y8630 60V 3A 500KHz Async Step-Down Regulator

R Y8630 Specifications

Absolute Maximum Ratings ^{(1) (2)}

Item	Min	Max	Unit
V _{IN} voltage	-0.3	65	V
EN voltage	-0.3	65	V
SW voltage	-0.3	V _{IN} +1V	V
SW voltage (10ns transient)	-5	V _{IN} +2V	V
BS voltage	-0.3	V _{sw} +5V	V
FB voltage	-0.3	6	V
All other pins voltage	-0.3	6.5	V
Power dissipation ⁽³⁾	Internally Limited		
Operating junction temperature, T _J	-40	150	°C
Storage temperature, T _{stg}	-55	150	°C
Lead Temperature (Soldering, 10sec.)		260	°C

Note (1): Exceeding these ratings may damage the device.

Note (2): The device is not guaranteed to function outside of its operating conditions.

Note (3): The maximum allowable power dissipation is a function of the maximum junction temperature, T_{J(MAX)}, the junction-to-ambient thermal resistance, R_{θJA}, and the ambient temperature, T_A. The maximum allowable power dissipation at any ambient temperature is calculated using: P_{D(MAX)} = (T_{J(MAX)} - T_A)/R_{θJA}. Exceeding the maximum allowable power dissipation causes excessive die temperature, and the regulator goes into thermal shutdown. Internal thermal shutdown circuitry protects the device from permanent damage. Thermal shutdown engages at T_J=160°C (typical) and disengages at T_J= 130°C (typical).

ESD Ratings

Item	Description	Value	Unit
V _(ESD-HBM)	Human Body Model (HBM) ANSI/ESDA/JEDEC JS-001-2014 Classification, Class: 2	±2000	V
V _(ESD-CDM)	Charged Device Mode (CDM) ANSI/ESDA/JEDEC JS-002-2014 Classification, Class: C0b	±200	V
I _{LATCH-UP}	JEDEC STANDARD NO.78E APRIL 2016 Temperature Classification, Class: I	±150	mA

Recommended Operating Conditions

Item	Min	Max	Unit
Operating junction temperature ⁽¹⁾	-40	125	°C
Operating temperature range	-40	85	°C
Input voltage V _{IN}	4.5	60	V
Output voltage V _{OUT}	1	48	V



R Y8630 60V 3A 500KHz Async Step-Down Regulator

Output current	0	3	A
----------------	---	---	---

Note (1): All limits specified at room temperature ($T_A = 25^\circ\text{C}$) unless otherwise specified. All room temperature limits are 100% production tested. All limits at temperature extremes are ensured through correlation using standard Statistical Quality Control (SQC) methods. All limits are used to calculate Average Outgoing Quality Level (AOQL).

Thermal Information

Item	Description	Value	Unit
$R_{\theta JA}$	Junction-to-ambient thermal resistance ⁽¹⁾⁽²⁾	48.7	$^\circ\text{C}/\text{W}$
$R_{\theta JC(\text{top})}$	Junction-to-case (top) thermal resistance	52.4	$^\circ\text{C}/\text{W}$
$R_{\theta JB}$	Junction-to-board thermal resistance	25.5	$^\circ\text{C}/\text{W}$
ψ_{JT}	Junction-to-top characterization parameter	8.4	$^\circ\text{C}/\text{W}$
ψ_{JB}	Junction-to-board characterization parameter	25.2	$^\circ\text{C}/\text{W}$
θ_{JCbot}	Junction-to-case (bottom) thermal resistance	6.5	$^\circ\text{C}/\text{W}$

Note (1): The package thermal impedance is calculated in accordance to JESD 51-7.

Note (2): Thermal Resistances were simulated on a 4-layer, JEDEC board

R Y8630 Electrical Characteristics ^{(1) (2)}

$T_A=25^\circ\text{C}$, unless otherwise specified.

Parameter	Test Conditions	Min	Typ.	Max	Unit
Input Voltage Range		4.5		60	V
Supply Current (Quiescent)	$V_{EN}=3.0\text{V}$		0.65	0.8	mA
Supply Current (Shutdown)	$V_{EN}=0$ or $EN = \text{GND}$		4	10	μA
Feedback Voltage		0.780	0.800	0.820	V
Output Over-Voltage Reference	V_{OVREF}		0.92		V
Switch-On Resistance	$I_{SW}=100\text{mA}$		150		$\text{m}\Omega$
Upper Switch Current Limit		4			A
Over Voltage Protection Threshold			62		V
Switching Frequency			500		KHz
Maximum Duty Cycle	$V_{FB}=90\%$		90		%
Minimum On-Time			170		nS
EN Rising Threshold		1.4			V
EN Falling Threshold				0.8	V
Under-Voltage Lockout Threshold	Wake up V_{IN} Voltage		4.2	4.5	V
	Shutdown V_{IN} Voltage	3.5	3.8		V
	Hysteresis V_{IN} voltage		400		mV
Thermal Shutdown			150		$^\circ\text{C}$
Thermal Hysteresis			30		$^\circ\text{C}$

Note (1): MOSFET on-resistance specifications are guaranteed by correlation to wafer level measurements.

Note (2): Thermal shutdown specifications are guaranteed by correlation to the design and characteristics analysis.



RY8630 60V 3A 500KHz Async Step-Down Regulator

RY8630 Typical Performance Characteristics (1) (2)

Note (1): Performance waveforms are tested on the evaluation board.

Note (2): $V_{IN}=12V$, $V_{OUT}=3.3V$, $T_A = +25^{\circ}C$, unless otherwise noted.

Efficiency vs Load Current

$V_{IN}=12V$, $V_{OUT}=5V/3.3V/1.2V$

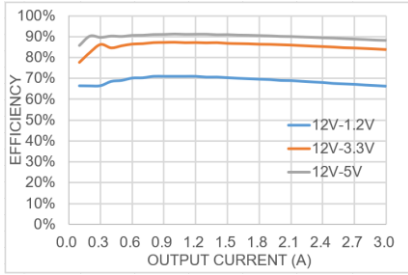

Load Regulation

$V_{IN}=12V$, $V_{OUT}=5V/3.3V/1.2V$

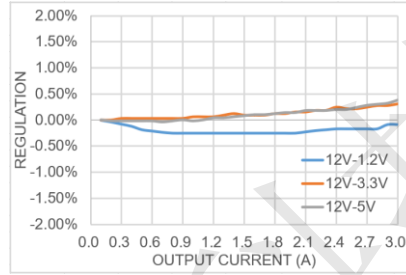

Line Regulation

$V_{OUT}=3.3V$, $I_{OUT}=0A/1.5A/3A$

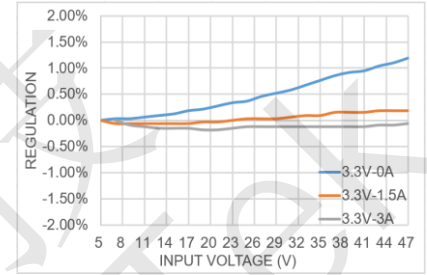

Efficiency vs Load Current

$V_{IN}=48V$, $V_{OUT}=12V/5V/3.3V$

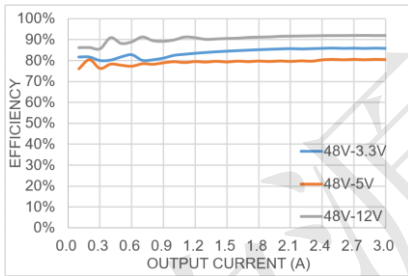

Load Regulation

$V_{IN}=48V$, $V_{OUT}=12V/5V/3.3V$

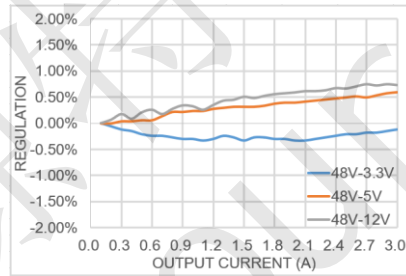

Line Regulation

$V_{OUT}=12V$, $I_{OUT}=0A/1.5A/3A$

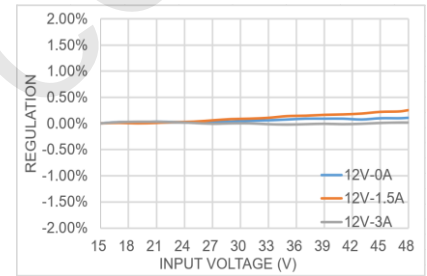

Output Ripple Voltage

$V_{IN}=48V$, $V_{OUT}=12V$, $I_{OUT}=0A$

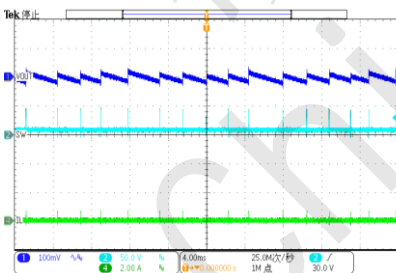

Output Ripple Voltage

$V_{IN}=48V$, $V_{OUT}=12V$, $I_{OUT}=1.5A$

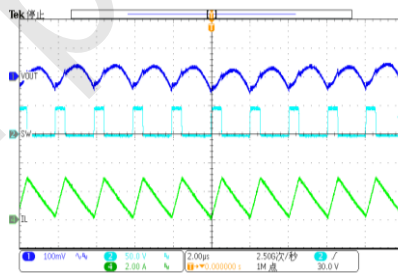

Output Ripple Voltage

$V_{IN}=48V$, $V_{OUT}=12V$, $I_{OUT}=3A$

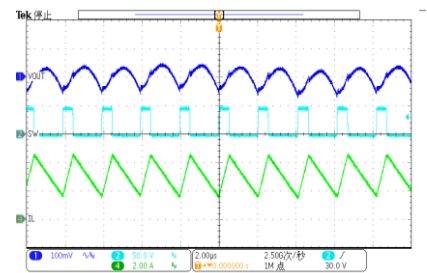



Ry8630 60V 3A 500KHz Async Step-Down Regulator

Loop Response

$V_{IN}=48V$, $V_{OUT}=12V$, $I_{OUT}=1.5A-3A$

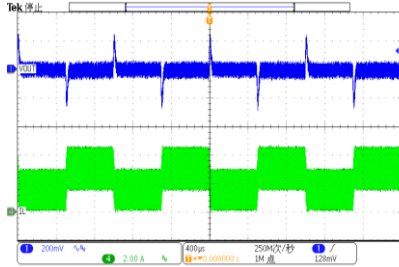

Output Short

$V_{IN}=48V$, $V_{OUT}=12V$

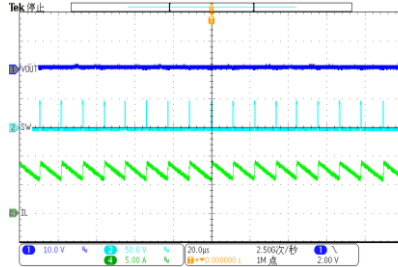

Short Circuit Entry

$V_{IN}=48V$, $V_{OUT}=12V$

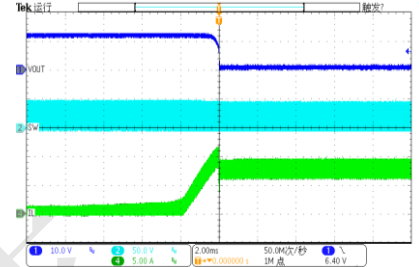

Short Circuit Recovery

$V_{IN}=48V$, $V_{OUT}=12V$

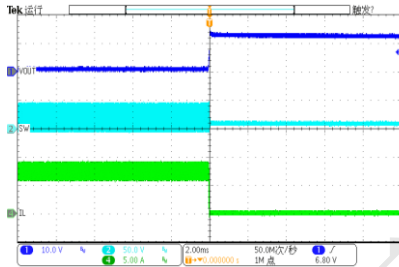

Enable Startup at No Load

$V_{IN}=48V$, $V_{OUT}=12V$, $I_{OUT}=0A$

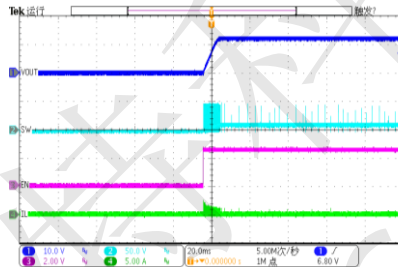

Enable Shutdown at No Load

$V_{IN}=48V$, $V_{OUT}=12V$, $I_{OUT}=0A$

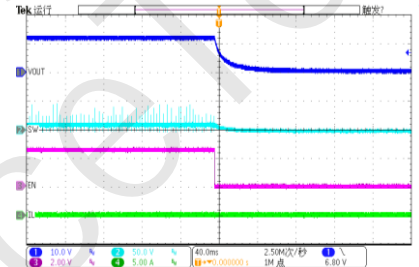

Enable Startup at Full Load

$V_{IN}=48V$, $V_{OUT}=12V$, $I_{OUT}=3A$

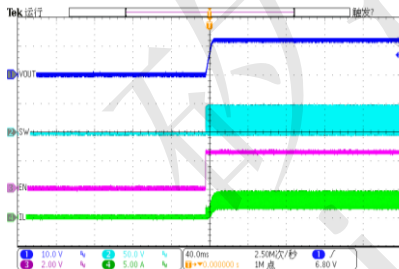

Enable Shutdown at Full Load

$V_{IN}=48V$, $V_{OUT}=12V$, $I_{OUT}=3A$

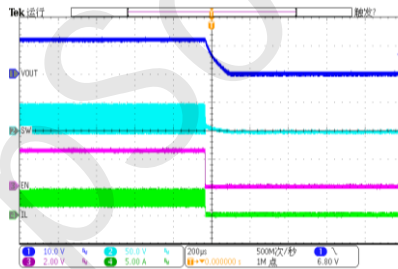

Power Up at No Load

$V_{IN}=48V$, $V_{OUT}=12V$, $I_{OUT}=0A$

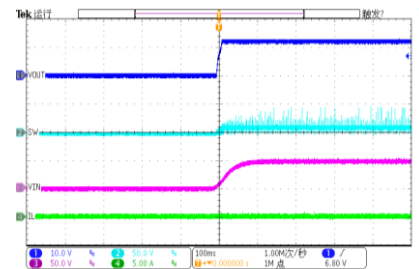

Power Up at Full Load

$V_{IN}=48V$, $V_{OUT}=12V$, $I_{OUT}=3A$

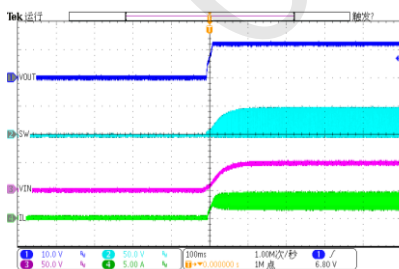

OVP Enter

$V_{IN}=48V$, $V_{OUT}=12V$, $I_{OUT}=3A$

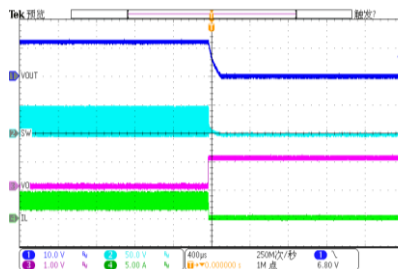

OVP Recovery

$V_{IN}=48V$, $V_{OUT}=12V$, $I_{OUT}=3A$

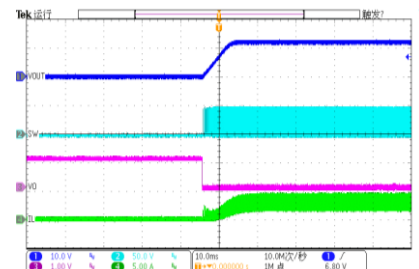



RY8630 60V 3A 500KHz Async Step-Down Regulator

command.

Current Mode Control

The RY8630 adjusts the output voltage through the current control mode, obtains the input signal from FB, amplifies it through the internal error amplifier, and compares it with the voltage drop across the resistor through the current of the inductor. Use this to control the internal driver to control the switching of the MOSFET.

PSM Mode

The RY8630 operates in PSM mode at light load. In PSM mode, switch frequency decreases when load current drops to boost power efficiency at light load by reducing switch-loss, while switch frequency increases when load current rises, minimizing output voltage ripples.

Internal Soft-Start

The soft-start is implemented to prevent the converter output voltage from overshooting during startup. When the chip starts, the internal circuitry generates a soft-start voltage (SS) ramping up from 0V to 0.8V. When it is lower than the internal reference (REF), SS overrides REF so the error amplifier uses SS as the reference. When SS is higher than REF, REF regains control.

Over Current Protection

The RY8630 has cycle-by-cycle over current limit when the inductor current peak value exceeds the set current limit threshold. Meanwhile, output voltage starts to drop until FB is below the Under-Voltage (UV) threshold. When the output is shorted to the ground, the switching frequency is folded back and the current limit is reduced to lower the short circuit current. The frequency foldback helps prevent inductor current runaway and thermal issue during short circuit. The RY8630 exits the foldback mode once the over current condition is removed.

Thermal Shutdown

Thermal shutdown prevents the chip from operating at exceedingly high temperatures. When the silicon die temperature exceeds 150°C, it shuts down the whole chip. When the temperature falls below its lower threshold (Typ. 130°C) the chip is enabled again.

Output Over-Voltage Protection

The RY8630 has output over-voltage protection (OVP), where VOUT connects to VO through an external resistor divider, and a 0.9V reference on the negative input of the OVP comparator. If the voltage on VO pin is greater than 0.9V, the high-side switch turns off after a short delay, and the soft-start capacitor discharges. If the voltage is less than 0.9V, the part restarts automatically.

Short Protection

The RY8630 has short protection (SP), where 10uA is supplied to SP directly to detect SP short-circuit. The system output Latch is always 0. If short-circuit condition is off, the system will be restarted.



R Y8630 60V 3A 500KHz Async Step-Down Regulator

R Y8630 Applications Information

Setting the Output Voltage

R Y8630 require an input capacitor, an output capacitor and an inductor. These components are critical to the performance of the device. R Y8630 integrates internal loop compensating resistors, so we do not recommend using a value of around 300K for R₁. The output voltage can be programmed by resistor divider.

$$V_{OUT} = V_{FB} \times \frac{R1 + R2}{R2}$$

V _{OUT} (V)	R1(KΩ)	R2(KΩ)	L1(μH)	C1(nF)	C _{IN} (μF)	C _{OUT} (μF)	C _{FF} (pF) Opt.
1.2	100	200	10	100	22	22×2	<u>C_{FF} Chapter</u>
2.5	100	47.06	10	100	22	22×2	<u>C_{FF} Chapter</u>
3.3	100	32	10	100	22	22×2	<u>C_{FF} Chapter</u>
5	100	19.05	15	100	22	22×2	<u>C_{FF} Chapter</u>
9	100	9.76	22	100	22	22×2	<u>C_{FF} Chapter</u>
12	100	7.14	33	100	22	22×2	<u>C_{FF} Chapter</u>

All the external components are the suggested values, the final values are based on the application testing results.

Selecting the Inductor

The recommended inductor values are shown in the Application Diagram. It is important to guarantee the inductor core does not saturate during any foreseeable operational situation. The inductor should be rated to handle the maximum inductor peak current: Care should be taken when reviewing the different saturation current ratings that are specified by different manufacturers. Saturation current ratings are typically specified at 25°C, so ratings at maximum ambient temperature of the application should be requested from the manufacturer. The inductor value can be calculated with:

$$L = \frac{V_{OUT} \times (V_{IN} - V_{OUT})}{V_{IN} \times \Delta I_L \times F_{OSC}}$$

Where ΔI_L is the inductor ripple current. Choose inductor ripple current to be approximately 30% to 40% of the maximum load current. The maximum inductor peak current can be estimated as:

$$I_{L(MAX)} = I_{LOAD} + \frac{\Delta I_L}{2}$$

Under light load conditions below 100mA, larger inductance is recommended for improved efficiency. Larger inductances lead to smaller ripple currents and voltages, but they also have larger physical dimensions, lower saturation currents and higher linear impedance. Therefore, the choice of inductance should be compromised according to the specific application.



RY8630 60V 3A 500KHz Async Step-Down Regulator

Selecting the Input Capacitor

The input current to the step-down converter is discontinuous and therefore requires a capacitor to supply AC current to the step-down converter while maintaining the DC input voltage. For a better performance, use ceramic capacitors placed as close to V_{IN} as possible and a $0.1\mu\text{F}$ input capacitor to filter out high frequency interference is recommended. Capacitors with X5R and X7R ceramic dielectrics are recommended because they are stable with temperature fluctuations.

The capacitors must also have a ripple current rating greater than the maximum input ripple current of the converter. The input ripple current can be estimated with Equation:

$$I_{CIN} = I_{OUT} \times \sqrt{\frac{V_{OUT}}{V_{IN}} \times \left(1 - \frac{V_{OUT}}{V_{IN}}\right)}$$

From the above equation, it can be concluded that the input ripple current reaches its maximum at $V_{IN}=2V_{OUT}$ where $I_{CIN} = \frac{I_{OUT}}{2}$. For simplification, choose an input capacitor with an RMS current rating greater than half of the maximum load current.

The input capacitance value determines the input voltage ripple of the converter. If there is an input voltage ripple requirement in the system, choose the input capacitor that meets the specification. The input voltage ripple can be estimate with Equation:

$$\Delta V_{IN} = \frac{I_{OUT}}{F_{OSC} \times C_{IN}} \times \frac{V_{OUT}}{V_{IN}} \times \left(1 - \frac{V_{OUT}}{V_{IN}}\right)$$

Similarly, when $V_{IN}=2V_{OUT}$, input voltage ripple reaches its maximum of $\Delta V_{IN} = \frac{1}{4} \times \frac{I_{OUT}}{F_{OSC} \times C_{IN}}$.

Selecting the Output Capacitor

An output capacitor is required to maintain the DC output voltage. The output voltage ripple can be estimated with Equation:

$$\Delta V_{OUT} = \frac{V_{OUT}}{F_{OSC} \times L} \times \left(1 - \frac{V_{OUT}}{V_{IN}}\right) \times \left(R_{ESR} + \frac{1}{8 \times F_{OSC} \times C_{OUT}}\right)$$

There are some differences between different types of capacitors. In the case of ceramic capacitors, the impedance at the switching frequency is dominated by the capacitance. The output voltage ripple is mainly caused by the capacitance. For simplification, the output voltage ripple can be estimated with Equation:

$$\Delta V_{OUT} = \frac{V_{OUT}}{8 \times F_{OSC}^2 \times L \times C_{OUT}} \times \left(1 - \frac{V_{OUT}}{V_{IN}}\right)$$

A larger output capacitor can achieve a better load transient response, but the maximum output capacitor limitation should also be considered in the design application. If the output capacitor value is too high, the output voltage will not be able to reach the design value during the soft-start time and will fail to regulate. The maximum output capacitor value (C_{OUT_MAX}) can be limited approximately with Equation:

$$C_{OUT_MAX} = (I_{LIM_AVG} - I_{OUT}) \times T_{SS} / V_{OUT}$$



RY8630 60V 3A 500KHz Async Step-Down Regulator

Where L_{LIM_AVG} is the average start-up current during the soft-start period, and T_{SS} is the soft-start time.

On the other hand, special attention should be paid when selecting these components. The DC bias of these capacitors can result in a capacitance value that falls below the minimum value given in the recommended capacitor specifications table.

The ceramic capacitor's actual capacitance can vary with temperature. The capacitor type X7R, which operates over a temperature range of -55°C to $+125^{\circ}\text{C}$, will only vary the capacitance to within $\pm 15\%$. The capacitor type X5R has a similar tolerance over a reduced temperature range of -55°C to $+85^{\circ}\text{C}$. Many large value ceramic capacitors, larger than $1\mu\text{F}$ are manufactured with Z5U or Y5V temperature characteristics. Their capacitance can drop by more than 50% as the temperature varies from 25°C to 85°C . Therefore, X5R or X7R is recommended over Z5U and Y5V in applications where the ambient temperature will change significantly above or below 25°C .

Feed-Forward Capacitor (C_{FF})

RY8630 has internal loop compensation, so adding C_{FF} is optional. Specifically, for specific applications, if necessary, consider whether to add feed-forward capacitors according to the situation.

The use of a feed-forward capacitor (C_{FF}) in the feedback network is to improve the transient response or higher phase margin. For optimizing the feed-forward capacitor, knowing the cross frequency is the first thing. The cross frequency (or the converter bandwidth) can be determined by using a network analyzer. When getting the cross frequency with no feed-forward capacitor identified, the value of feed-forward capacitor (C_{FF}) can be calculated with the following Equation:

$$C_{FF} = \frac{1}{2\pi \times F_{CROSS}} \times \sqrt{\frac{1}{R1} \times \left(\frac{1}{R1} + \frac{1}{R2}\right)}$$

Where F_{CROSS} is the cross frequency.

To reduce transient ripple, the feed-forward capacitor value can be increased to push the cross frequency to higher region. Although this can improve transient response, it also decreases phase margin and cause more ringing. In the other hand, if more phase margin is desired, the feed-forward capacitor value can be decreased to push the cross frequency to lower region.

External Bootstrap Diode

Add an external bootstrap diode when the system has a fixed 5V input or when the power supply generates a 5V output. This helps improve the efficiency of the regulator. The bootstrap diode can be a low-cost one. This diode is also recommended for high-duty-cycle operation (when $\frac{V_{OUT}}{V_{IN}} > 65\%$) and high output voltage ($V_{OUT} > 12\text{V}$) applications.

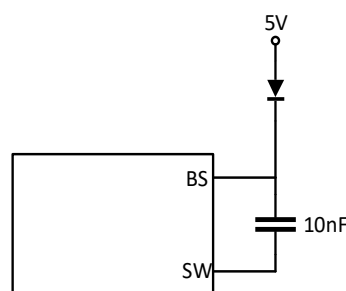

External Bootstrap Diode



RY8630 60V 3A 500KHz Async Step-Down Regulator

PC Board Layout Consideration

PCB layout is very important to achieve stable operation and better performance. It is highly recommended to duplicate EVB layout for optimum performance. If change is necessary, please follow these guidelines for reference.

1. Keep the path of switching current short and minimize the loop area formed by Input capacitor, high-side MOSFET and low-side MOSFET.
2. Bypass ceramic capacitors are suggested to be put close to the VIN Pin.
3. Ensure all feedback connections are short and direct. Place the feedback resistors and compensation components as close to the chip as possible.
4. VOUT, SW away from sensitive analog areas such as FB.
5. Connect IN, SW, and especially GND respectively to a large copper area to cool the chip to improve thermal performance and long-term reliability.

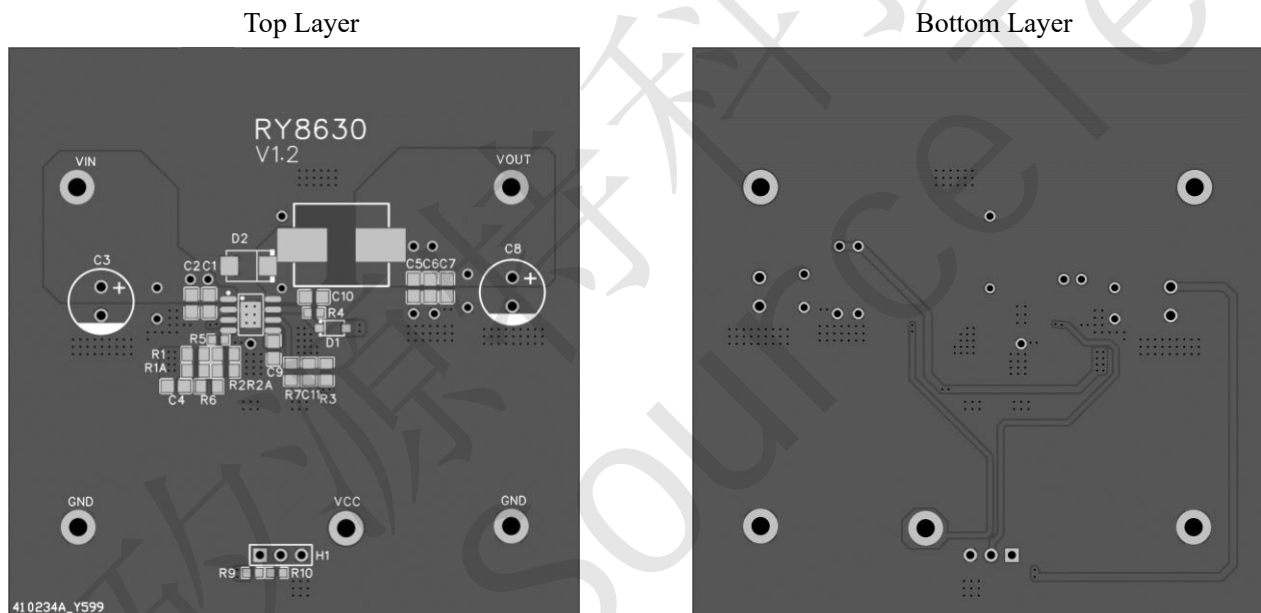

Sample Board Layout



RY8630 60V 3A 500KHz Async Step-Down Regulator

RY8630 Package Description

ESOP8 (EXPOSED PAD)

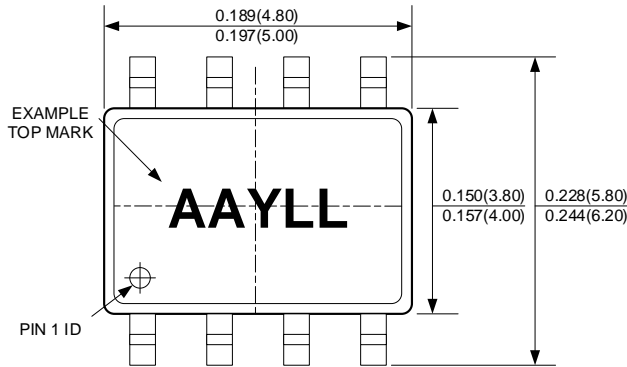

TOP VIEW

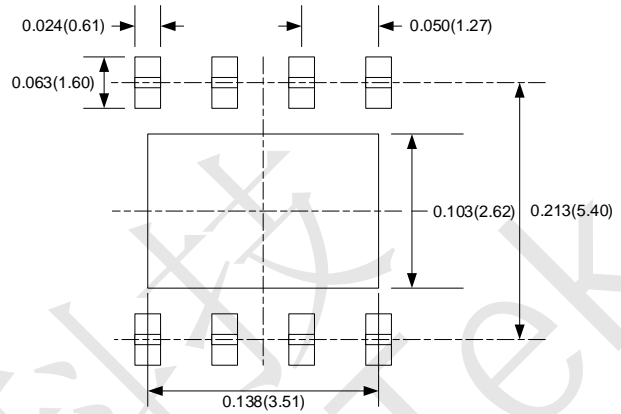

RECOMMENDED PAD LAYOUT

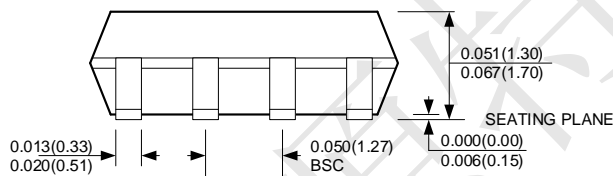

FRONT VIEW

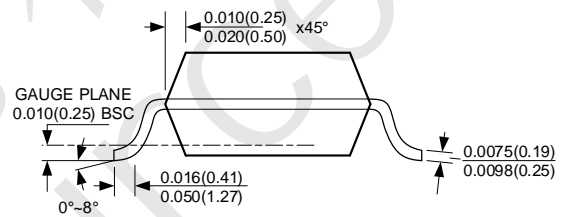

SIDE VIEW

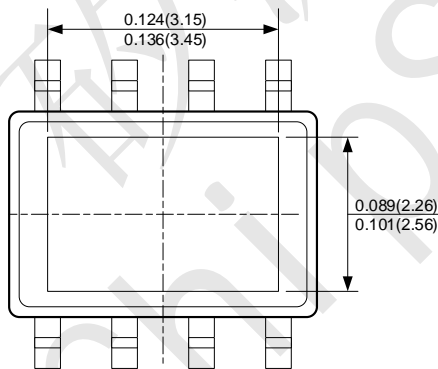

BOTTOM VIEW

NOTE:

1. CONTROL DIMENSION IS IN INCHES. DIMENSION IN BRACKET IS IN MILLIMETERS.
2. PACKAGE LENGTH DOES NOT INCLUDE MOLD FLASH, PROTRUSIONS OR GATE BURRS.
3. PACKAGE WIDTH DOES NOT INCLUDE INTERLEAD FLASH OR PROTRUSIONS.
4. LEAD COPLANARITY (BOTTOM OF LEADS AFTER FORMING) SHALL BE 0.004" INCHES MAX.
5. DRAWING CONFORMS TO JEDEC MS-012, VARIATION BA.
6. DRAWING IS NOT TO SCALE.