



### AB类/D类切换功能, 5.3W 输出功率 单通道音频功率放大器

#### 概要

HAA8872是一款FM无干扰、AB/D类可切换、高效率、无滤波器的5.3W单声道音频功率放大器。超低的EMI非常适合应用于带FM功能的便携式设备中。

HAA8872的单端输入架构和极高的PSRR有效地提高了HAA8872对RF噪声的抑制能力。无需滤波器的PWM调制结构及增益内置方式减少了外部元件、PCB面积和系统成本,并简化了设计。高达90%的效率,快速地启动时间和纤小的封装尺寸使得HAA8872成为便携式音频产品的最佳选择。

HAA8872具有极低的关断电流,极大的延长系统的待机时间。OCP、OTP、UVLO保护功能增强系统的可靠性。开启、关闭POP-click抑制功能改善了系统的听觉感受,同时简化系统调试。

HAA8872提供带散热片的ESOP8封装

#### 特性

- AB类、D类切换功能
- D类输出功率:
  - 5.3W (VDD=5.0V,  $R_L = 2\Omega$ , THD+N=10%)
  - 3.2W (VDD=5.0V,  $R_L = 4\Omega$ , THD+N=10%)
- AB类输出功率:
  - 5.2W (VDD=5.0V,  $R_L = 2\Omega$ , THD+N=10%)
  - 3.1W (VDD=5.0V,  $R_L = 4\Omega$ , THD+N=10%)
- 工作电压范围: 2.5V to 5.5V
- 低失真和低噪声
- 开启、关闭POP-click抑制功能
- 关断电流 (<1uA)
- OCP、OTP、UVLO保护功能

#### 应用

- 扩音器
- 便携式音箱 / 插卡音箱
- 蓝牙音箱 / USB音箱

#### 典型应用电路图

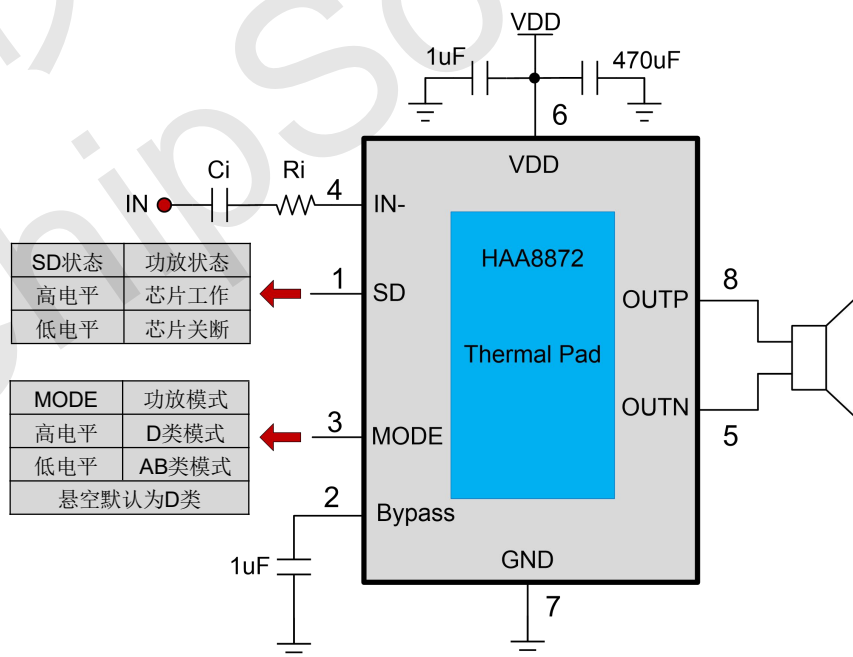



### AB 类/D 类切换功能，5.3W 输出功率 单通道音频功率放大器

#### 引脚排列

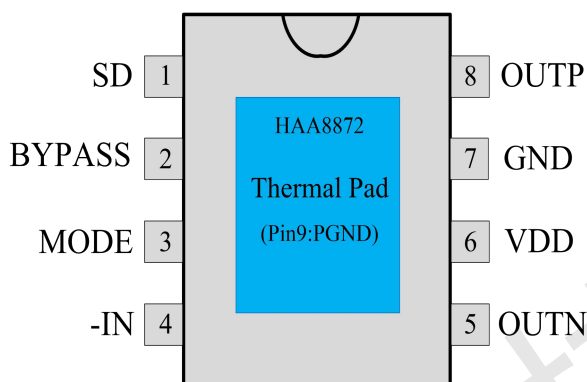

#### 管脚描述

管脚	符号	I/O	描述
1	SD	I	系统关断控制（高电平工作，低电平关断）
2	BYPASS	I	参考电压
3	MODE	I/O	D 类，AB 类选择（高电平 D 类，低电平 AB 类）
4	-IN	I	音频负输入端
5	OUTN	O	音频负输出端
6	VDD		电源
7	GND		地
8	OUTP	O	音频正输出端
9(Thermal Pad)	GND		芯片底部散热片接地



### AB 类/D 类切换功能, 5.3W 输出功率 单通道音频功率放大器

#### 订购信息

料号	封装	表面印字	包装
HAA8872	ESOP8	HAA8872 (A) PST XXXXXXXX	100颗/管

#### 极限参数表

V <sub>DD</sub>	供电电压	-0.3V to 6.0V
V <sub>I</sub>	输入电压	-0.3V to V <sub>DD</sub> +0.3V
T <sub>A</sub>	工作温度	-40°C to 85°C
T <sub>J</sub>	结温	-40°C to 125°C
T <sub>STG</sub>	储存温度	-65°C to 150°C
T <sub>SLD</sub>	焊接温度	300°C, 5sec

#### 推荐的工作条件

			MIN	MAX	UNIT
V <sub>DD</sub>	供电电压	V <sub>DD</sub>	2.5	5.5	V
V <sub>IH</sub>	SD高电平	V <sub>DD</sub> =5.0V	1.3		V
	MODE高电平		1.3		
V <sub>IL</sub>	SD低电平	V <sub>DD</sub> =5.0V		0.35	V
	MODE低电平			0.35	V

#### 热效应参数

Parameter	Symbol	Package	MAX	UNIT
热阻 (Junction to Ambient)	θ <sub>JA</sub>	ESOP8	40	°C/W
热阻 (Junction to Case)	θ <sub>JC</sub>	ESOP8	11	°C/W



### AB类/D类切换功能，5.3W输出功率 单通道音频功率放大器

#### D类 电气特性

(Gain=23dB,  $R_L=4\Omega$ ,  $T=25^\circ\text{C}$ , unless otherwise noted.)

Symbol	Parameter	Test Conditions	MIN	TYP	MAX	UNIT
P <sub>o</sub>	D类模式输出功率	THD+N=10%, f=1KHZ, R <sub>L</sub> =4Ω	V <sub>DD</sub> =5.0V	3.2		W
			V <sub>DD</sub> =3.7V	1.7		
		THD+N=1%, f=1KHZ, R <sub>L</sub> =4Ω	V <sub>DD</sub> =5.0V	2.6		W
			V <sub>DD</sub> =3.7V	1.4		
		THD+N=10%, f=1KHZ, R <sub>L</sub> =2Ω	V <sub>DD</sub> =5.0V	5.3		W
			V <sub>DD</sub> =3.7V	2.8		
		THD+N=1%, f=1KHZ, R <sub>L</sub> =2Ω	V <sub>DD</sub> =5.0V	4.2		W
			V <sub>DD</sub> =3.7V	2.2		
THD+N	总谐波失真+噪声	V <sub>DD</sub> =5.0V, P <sub>o</sub> =1W, R <sub>L</sub> =4Ω	f=1KHz	0.1		%
				V <sub>DD</sub> =3.7V, P <sub>o</sub> =1W, R <sub>L</sub> =4Ω	0.28	
		V <sub>DD</sub> =5.0V, P <sub>o</sub> =2W, R <sub>L</sub> =2Ω	f=1KHz	0.21		%
				V <sub>DD</sub> =3.7V, P <sub>o</sub> =2W, R <sub>L</sub> =2Ω	1.1	
G <sub>v</sub>	D类模式增益	R <sub>i</sub> = 22K		23		dB
PSRR	电源纹波抑制比	V <sub>DD</sub> =5V ±200mVp-p	f=217Hz	70		dB
SNR	信噪比	V <sub>DD</sub> =5.0V, V <sub>orms</sub> =1V, GV=23dB	f=1KHz	-85		dB
V <sub>n</sub>	残余噪声	V <sub>DD</sub> =5.0V, Input floating with C <sub>IN</sub> =0.1μF	A-weighting	75		μV
			No	110		
			A-weighting			
Dyn	动态范围	V <sub>DD</sub> =5.0V, THD=1%	f=1KHz	-90		dB
I <sub>q</sub>	静态电流	V <sub>DD</sub> =5.0V	No Load	4		mA
		V <sub>DD</sub> =3.0V		3.6		
η	效率	V <sub>DD</sub> =5V, R <sub>L</sub> =4Ω, P <sub>o</sub> =3W	f=1KHz	90		%
		V <sub>DD</sub> =5V, R <sub>L</sub> =2Ω, P <sub>o</sub> =5W	f=1KHz	85		
r <sub>DS(on)</sub>	源漏导通电阻	V <sub>DD</sub> =5V, I <sub>o</sub> =500mA	N+P	480		mΩ
Fosc	D类调制频率	V <sub>IN</sub> =2.5V to 5.0V		600		kHz
R <sub>in</sub>	内置输入电阻			5		KΩ
R <sub>f</sub>	内置反馈电阻			400		KΩ
I <sub>SD</sub>	关断电流	V <sub>IN</sub> =0V, V <sub>DD</sub> =5V		0.1	1	μA
V <sub>os</sub>	失调电压	V <sub>IN</sub> =0V, V <sub>DD</sub> =5V		10	30	mV
T <sub>st</sub>	启动时间	Bypass capacitor =1uF	V <sub>DD</sub> =5V	130		mS
OTP	—	No Load, Junction Temperature	V <sub>DD</sub> =5.0V	165		°C
OTH	—			15		



### AB类/D类切换功能，5.3W输出功率 单通道音频功率放大器

#### AB类 电气特性

(Gain=23dB,  $R_L=4\Omega$ ,  $T=25^\circ\text{C}$ , unless otherwise noted.)

Symbol	Parameter	Test Conditions	MIN	TYP	MAX	UNIT
P <sub>o</sub>	AB类模式输出功率	THD+N=10%, f=1KHZ, R <sub>L</sub> =4Ω	V <sub>DD</sub> =5.0V	3.1		W
			V <sub>DD</sub> =3.7V	1.65		
		THD+N=1%, f=1KHZ, R <sub>L</sub> =4Ω	V <sub>DD</sub> =5.0V	2.65		W
			V <sub>DD</sub> =3.7V	1.4		
		THD+N=10%, f=1KHZ, R <sub>L</sub> =2Ω	V <sub>DD</sub> =5.0V	5.2		W
			V <sub>DD</sub> =3.7V	2.78		
THD+N=1%, f=1KHZ, R <sub>L</sub> =2Ω	V <sub>DD</sub> =5.0V	4.15		W		
	V <sub>DD</sub> =3.7V	2.2				
THD+N	总谐波失真+噪声	V <sub>DD</sub> =5.0V, P <sub>o</sub> =1W, R <sub>L</sub> =4Ω	f=1KHz	0.09		%
				V <sub>DD</sub> =3.6V, P <sub>o</sub> =1W, R <sub>L</sub> =4Ω	0.23	
		V <sub>DD</sub> =5.0V, P <sub>o</sub> =2W, R <sub>L</sub> =2Ω	f=1KHz	0.2		%
				V <sub>DD</sub> =3.6V, P <sub>o</sub> =2W, R <sub>L</sub> =2Ω	1.05	
G <sub>v</sub>	D类模式增益	R <sub>i</sub> = 22K		23		dB
PSRR	电源纹波抑制比	V <sub>DD</sub> =5V ±200mVp-p	f=217Hz	70		dB
SNR	信噪比	V <sub>DD</sub> =5.0V, V <sub>orms</sub> =1V, G <sub>v</sub> =23dB	f=1KHz	-88		dB
V <sub>n</sub>	残余噪声	V <sub>DD</sub> =5.0V, Input floating with C <sub>IN</sub> =0.1μF	A-weighting	70		μV
			No	105		
			A-weighting			
Dyn	动态范围	V <sub>DD</sub> =5.0V, THD=1%	f=1KHz	-89		dB
I <sub>q</sub>	静态电流	V <sub>DD</sub> =5.0V	No Load	4.2		mA
				V <sub>DD</sub> =3.0V	3.8	
R <sub>in</sub>	内置输入电阻			5		K Ω
R <sub>f</sub>	内置反馈电阻			400		K Ω
I <sub>SD</sub>	关断电流	V <sub>IN</sub> =0V, V <sub>DD</sub> =5V		0.1	1	μA
V <sub>os</sub>	失调电压	V <sub>IN</sub> =0V, V <sub>DD</sub> =5V		10	30	mV
T <sub>st</sub>	启动时间	Bypass capacitor =1uF	V <sub>DD</sub> =5V	130		mS
OTP	—	No Load, Junction Temperature	V <sub>DD</sub> =5.0V	165		°C
OTH	—			15		



### AB 类/D 类切换功能, 5.3W 输出功率 单通道音频功率放大器

典型特征曲线 (D类工作模式, VDD =5V, Gain=23dB,  $R_L = 4\Omega$ , T =25°C, unless otherwise noted.)

THD+N vs Output Power

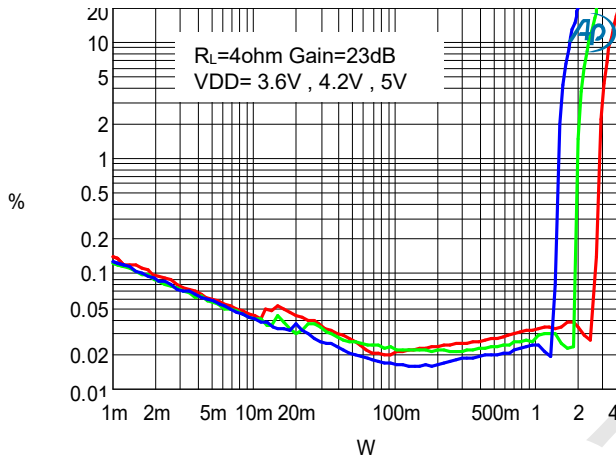

THD+N vs Output Power

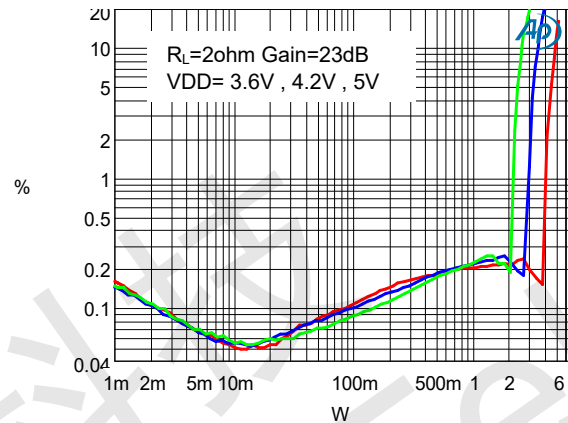

THD+N VS FREQUENCY

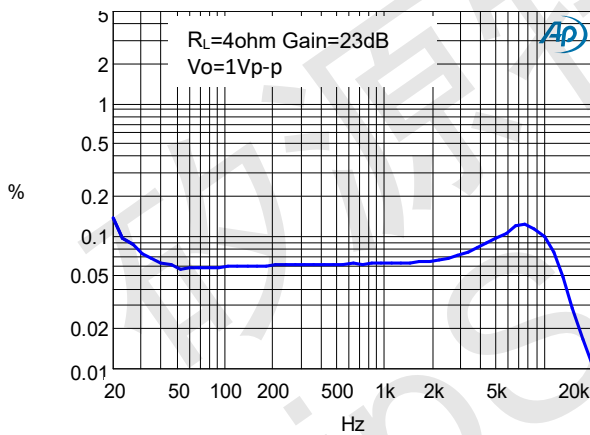

Frequency Response

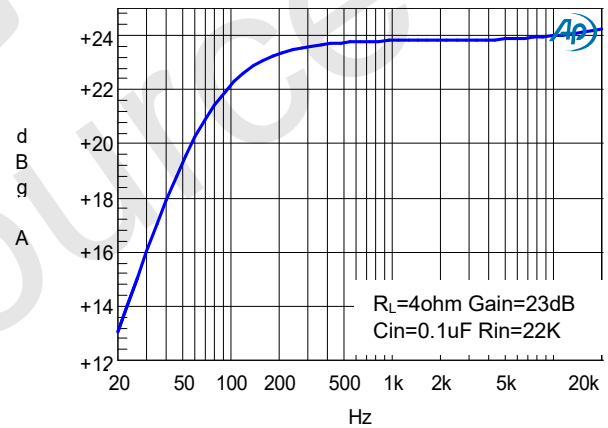

NOISE FLOOR FF

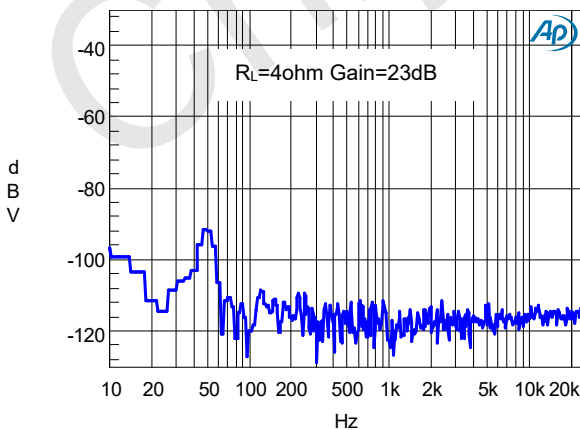



### AB类/D类切换功能, 5.3W 输出功率 单通道音频功率放大器

典型特征曲线(AB类工作模式, VDD =5V, Gain=23dB,  $R_L = 4\Omega$ , T =25°C, unless otherwise noted.)

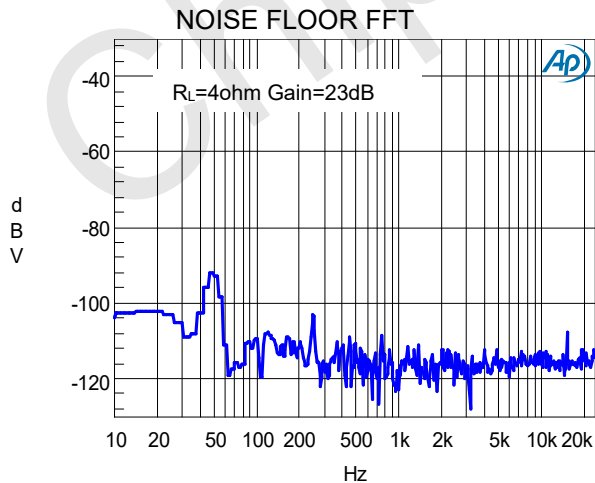
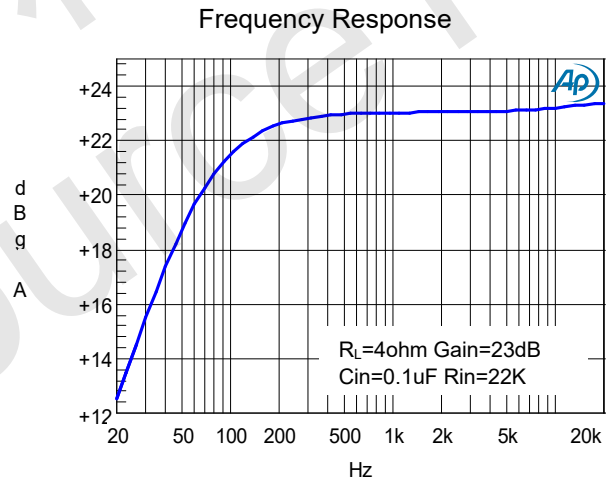
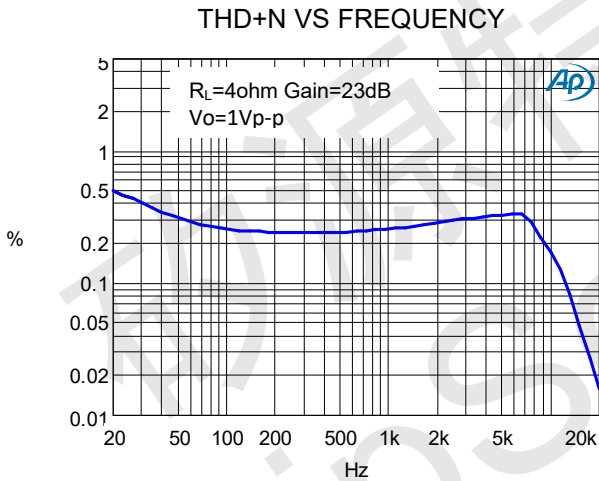
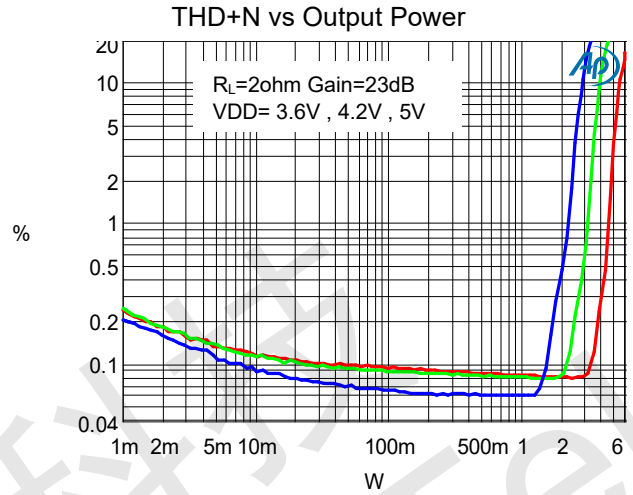
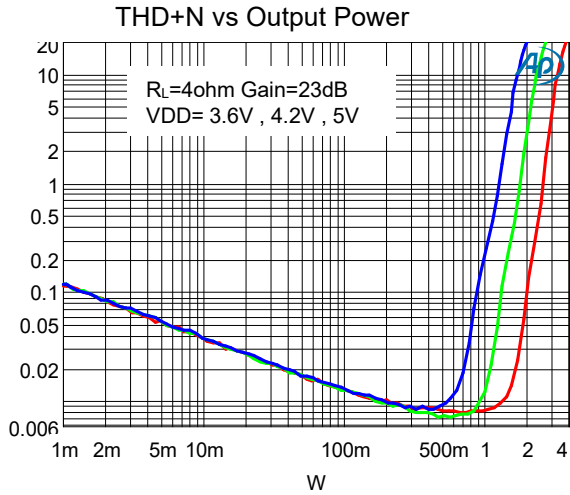



### AB类/D类切换功能，5.3W输出功率 单通道音频功率放大器

#### 应用信息

##### MODE模式

AB类，D类切换控制功能使用功放的第3管脚来控制。MODE管脚置高电平时HAA8872工作在D类的模式；MODE管脚置低电平时HAA8872工作在AB类的模式。

##### 输入电阻(Ri)

HAA8872的增益由音量调节控制的输入电阻(RI)和反馈电阻RF)控制。

增益计算公式：

$$A_v = \frac{R_f}{R_i + 5} \left( \frac{V}{V} \right)$$

其中，输入电阻RI为外部的输入电阻（HAA8872内部集成输入电阻为5KΩ），反馈电阻Rf为400KΩ（反馈电阻为内部固定，不可外部调节）。

例如，外部输入电阻为22K，则放大倍数为：

$$A_v = 400 / (22+5) = 14.8 \text{倍} = 23.4 \text{ dB}$$

##### 输入电容 (Ci)

输入电容与输入电阻构成一个高通滤波器，其截止频率可由下式得出：

$$f_c = \frac{1}{(2\pi R_i C_i)}$$

Ci的值不仅会影响到电路的低频响应，而且也会影响电路启动和关断时所产生的POP声，输入电容越大，则到达其稳定工作点所需的电荷越多，在同等条件下，小的输入电容所产生的POP声比较小。

##### Bypass电容CBYP

偏置电容是最关键的电容，它与几个重要性能相关，当电路启动时，偏置电容决定了放大器的开启速度，偏置电容同时会影响到电路的噪声,电源抑制比以及开关机的POP声。

为避免启动时的POP声，偏置电压的上升速度应该比输入偏置电压的上升速度慢。

##### SD工作模式

为了减少在关断模式下的功率损耗，HAA8872带有关闭放大器偏置的关断电路。当SD引脚为低电平时，放大器被关闭，工作电流达到最小。

##### 过温保护

HAA8872 带有过温保护电路以防止内部温度超过165°C时器件损坏。在不同器件之间，这个值有25°C的差异。当内部电路超过设置的保护温度时，器件进入关断状态，输出被截止。当温度下降 15°C后，器件重新正常工作。





#### AB 类/D 类切换功能, 5.3W 输出功率 单通道音频功率放大器

#### 封装图 (ESOP8)

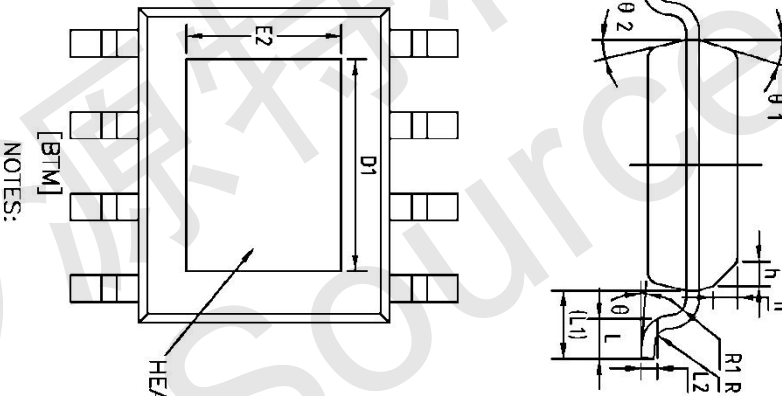
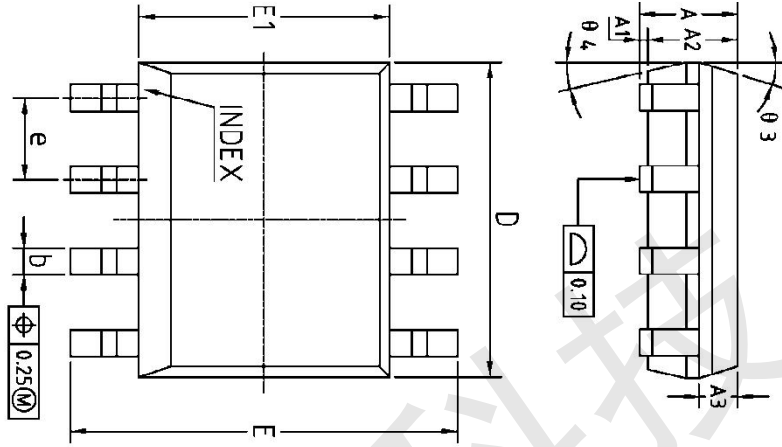

NOTES:  
 ALL DIMENSIONS REFER TO JEDEC STANDARD MS-012 AA  
 DO NOT INCLUDE MOLD FLASH OR PROTRUSIONS.

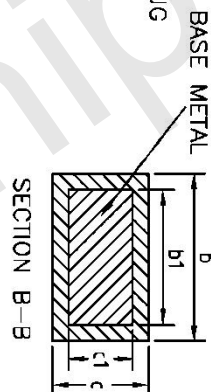

(UNITS OF MEASURE=MILLIMETER)

SYMBOL	MIN	NOM	MAX
A	1.35	1.55	1.75
A1	0	0.10	0.15
A2	1.25	1.40	1.65
A3	0.50	0.60	0.70
b	0.38	-	0.51
b1	0.37	0.42	0.47
c	0.17	0.20	0.25
c1	0.17	0.20	0.25
D	4.80	4.90	5.00
D1	3.10	3.30	3.50
E	5.80	6.00	6.20
E1	3.80	3.90	4.00
E2	2.20	2.40	2.60
e	-	1.27/BSC	2.60
L	0.45	0.60	0.80
L1	-	1.04REF	-
L2	-	0.25BSC	-
R	0.07	-	-
R1	0.07	-	-
h	0.30	0.40	0.50
theta	0°	-	8°
theta 1	15°	17°	19°
theta 2	11°	15°	19°
theta 3	15°	17°	19°
theta 4	11°	15°	19°