

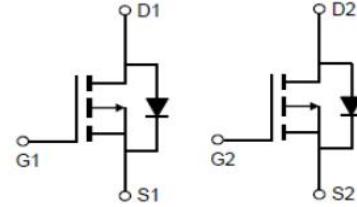

## Dual P-Channel Enhancement Mode Power MOSFET

### Description

The MX4805 uses advanced trench technology to provide excellent  $R_{DS(ON)}$ , low gate charge and operation with gate voltages as low as  $-4.5V$ . This device is suitable for use as a load switch or in PWM applications.



Schematic diagram

### General Features

$V_{DS} = -30V, I_D = -9A$

$R_{DS(ON)}$  (Typ.)  $12m\Omega$  @  $V_{GS} = -20V$

$R_{DS(ON)}$  (Typ.)  $13m\Omega$  @  $V_{GS} = -10V$

$R_{DS(ON)}$  (Typ.)  $20m\Omega$  @  $V_{GS} = -4.5V$

High Power and current handing capability

Lead free product is acquired

Surface mount package

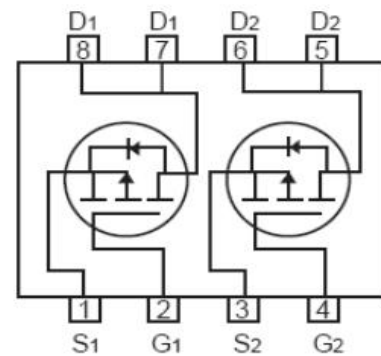

### Application

PWM applications

Load switch

Power management

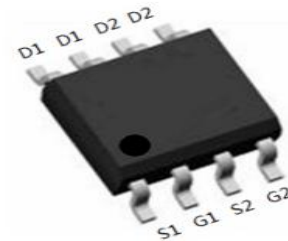

SOP-8 top view

### Absolute Maximum Ratings ( $T_A = 25^\circ C$ unless otherwise noted)

Parameter	Symbol	Limit	Unit
Drain-Source Voltage	$V_{DS}$	-30	V
Gate-Source Voltage	$V_{GS}$	$\pm 25$	V
Drain Current-Continuous	$I_D$	-9	A
Drain Current-Pulsed (Note 1)	$I_{DM}$	-27	A
Maximum Power Dissipation	$P_D$	2	W
Operating Junction and Storage Temperature Range	$T_J, T_{STG}$	-55 To 150	$^\circ C$

### Thermal Characteristic

Thermal Resistance, Junction-to-Ambient (Note 2)	$R_{\theta JA}$	41.67	$^\circ C/W$
--	-----------------	-------	--------------



**Electrical Characteristics (T<sub>A</sub>=25°C unless otherwise noted)**

Parameter	Symbol	Condition	Min	Typ	Max	Unit
<b>Off Characteristics</b>						
Drain-Source Breakdown Voltage	BV <sub>DSS</sub>	V <sub>GS</sub> =0V, I <sub>D</sub> =-250μA	-30	-	-	V
Zero Gate Voltage Drain Current	I <sub>DSS</sub>	V <sub>DS</sub> =-30V, V <sub>GS</sub> =0V	-	-	-1	μA
Gate-Body Leakage Current	I <sub>GSS</sub>	V <sub>GS</sub> =±25V, V <sub>DS</sub> =0V	-	-	±100	nA
<b>On Characteristics (Note 3)</b>						
Gate Threshold Voltage	V <sub>GS(th)</sub>	V <sub>DS</sub> =V <sub>GS</sub> , I <sub>D</sub> =-250μA	-1.5	-2.2	-3	V
Drain-Source On-State Resistance	R <sub>DS(on)</sub>	V <sub>GS</sub> =-20V, I <sub>D</sub> =-9A	-	12	15	mΩ
		V <sub>GS</sub> =-10V, I <sub>D</sub> =-8A	-	13	18	mΩ
		V <sub>GS</sub> =-4.5V, I <sub>D</sub> =-5A	-	20	35	mΩ
Forward Transconductance	g <sub>FS</sub>	V <sub>DS</sub> =-10V, I <sub>D</sub> =-10A	20	-	-	S
<b>Dynamic Characteristics (Note4)</b>						
Input Capacitance	C <sub>iss</sub>	V <sub>DS</sub> =-15V, V <sub>GS</sub> =0V, F=1.0MHz	-	2010	-	PF
Output Capacitance	C <sub>oss</sub>		-	346	-	PF
Reverse Transfer Capacitance	C <sub>rss</sub>		-	297	-	PF
<b>Switching Characteristics (Note 4)</b>						
Turn-on Delay Time	t <sub>d(on)</sub>	V <sub>DD</sub> =-15V, I <sub>D</sub> =-9A, V <sub>GS</sub> =-10V, R <sub>GEN</sub> =1Ω	-	11	-	nS
Turn-on Rise Time	t <sub>r</sub>		-	6	-	nS
Turn-Off Delay Time	t <sub>d(off)</sub>		-	28	-	nS
Turn-Off Fall Time	t <sub>f</sub>		-	10	-	nS
Total Gate Charge	Q <sub>g</sub>	V <sub>DS</sub> =-15V, I <sub>D</sub> =-9A, V <sub>GS</sub> =-10V	-	26	-	nC
Gate-Source Charge	Q <sub>gs</sub>		-	3.9	-	nC
Gate-Drain Charge	Q <sub>gd</sub>		-	9	-	nC
<b>Drain-Source Diode Characteristics</b>						
Diode Forward Voltage (Note 3)	V <sub>SD</sub>	V <sub>GS</sub> =0V, I <sub>S</sub> =-1A	-	-	-1	V

**Notes:**

1. Repetitive Rating: Pulse width limited by maximum junction temperature.
2. Surface Mounted on FR4 Board, t ≤ 10 sec.
3. Pulse Test: Pulse Width ≤ 300μs, Duty Cycle ≤ 2%.
4. Guaranteed by design, not subject to production



Typical Electrical and Thermal Characteristics

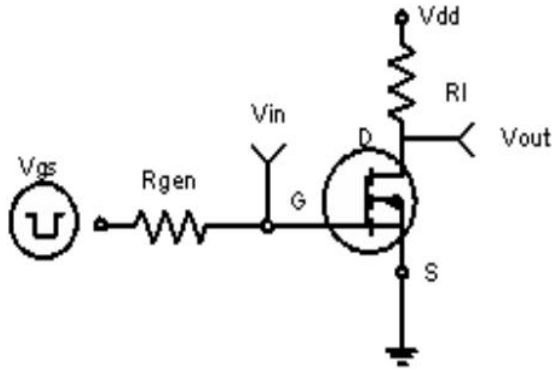

Figure 1: Switching Test Circuit

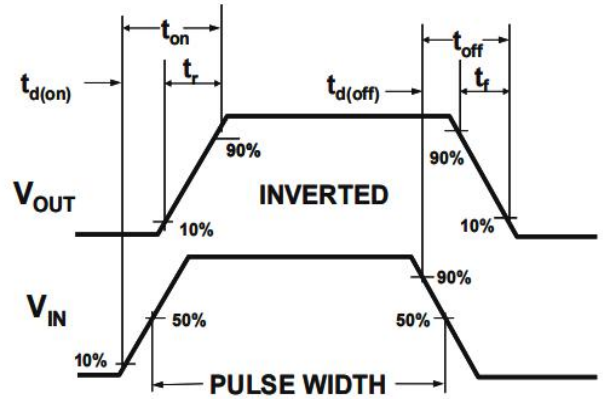

Figure 2: Switching Waveforms

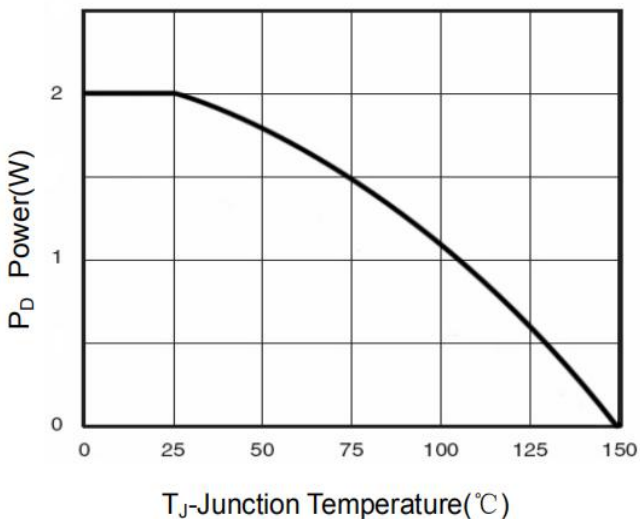

Figure 3 Power Dissipation

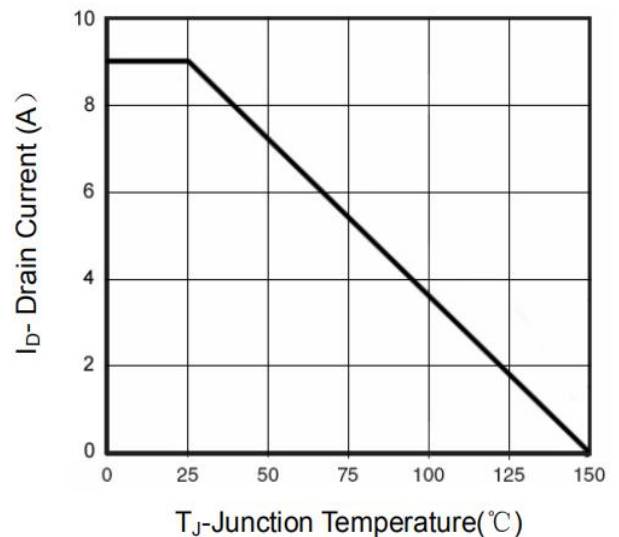

Figure 4 Drain Current

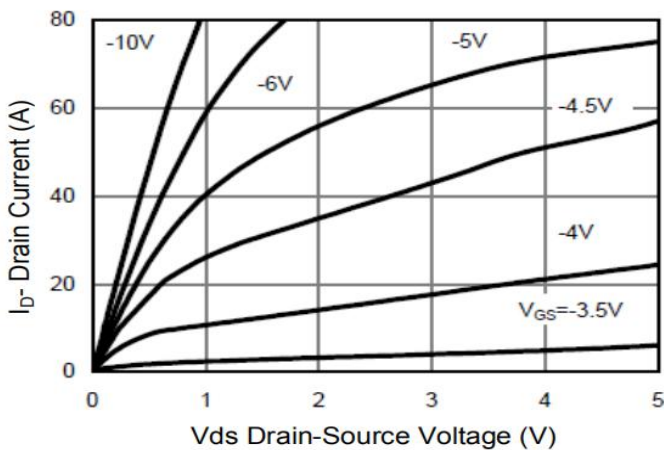

Figure 5 Output Characteristics

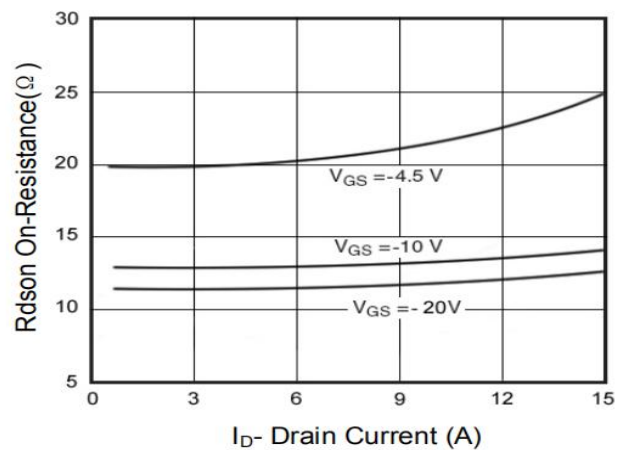
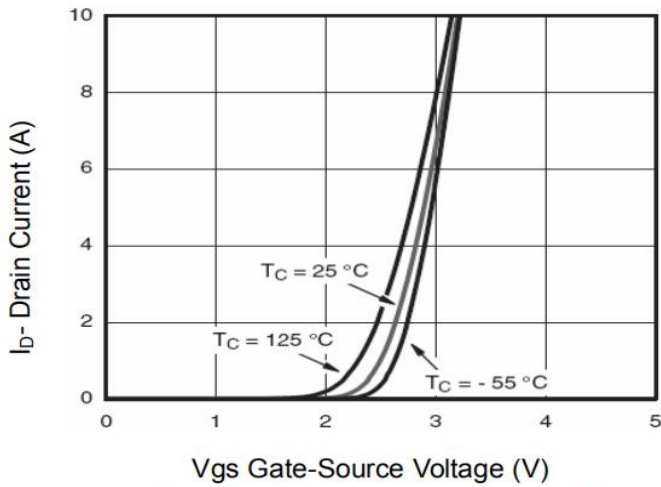
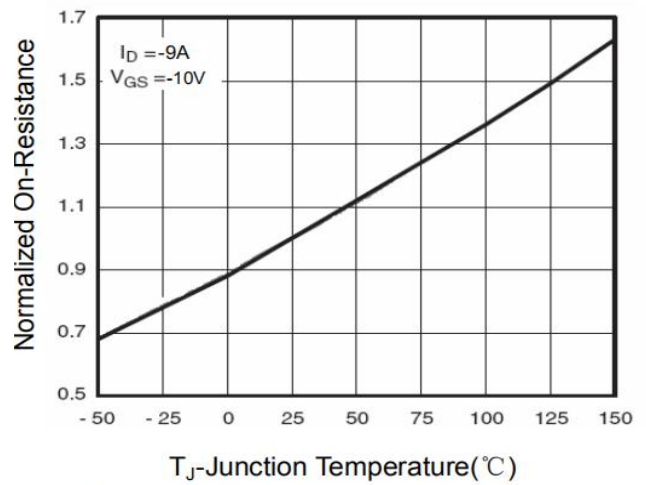

Figure 6 Drain-Source On-Resistance



**Figure 7 Transfer Characteristics**



**Figure 8 Drain-Source On-Resistance**

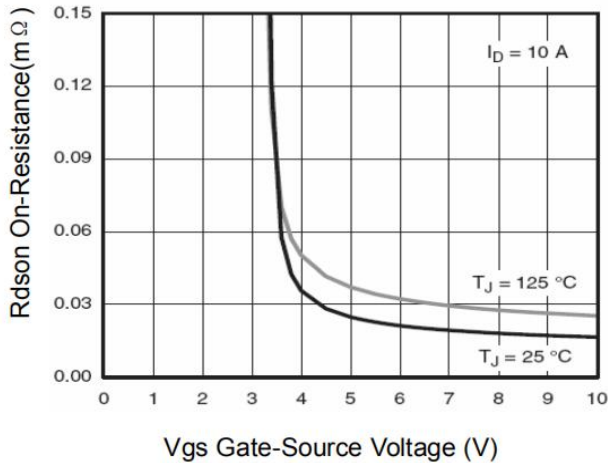

**Figure 9 Rdson vs Vgs**

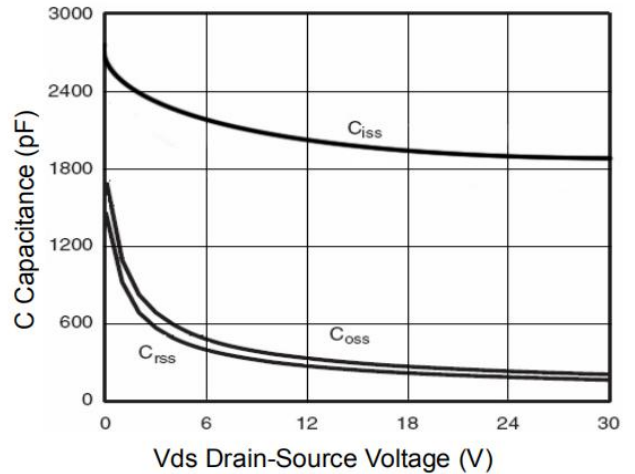

**Figure 10 Capacitance vs Vds**

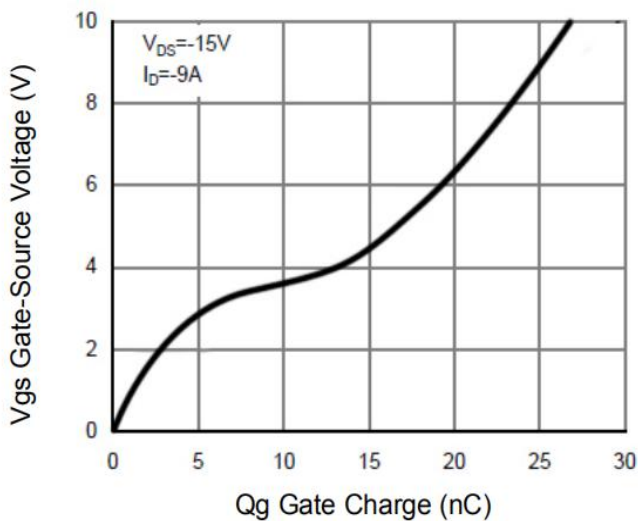

**Figure 11 Gate Charge**

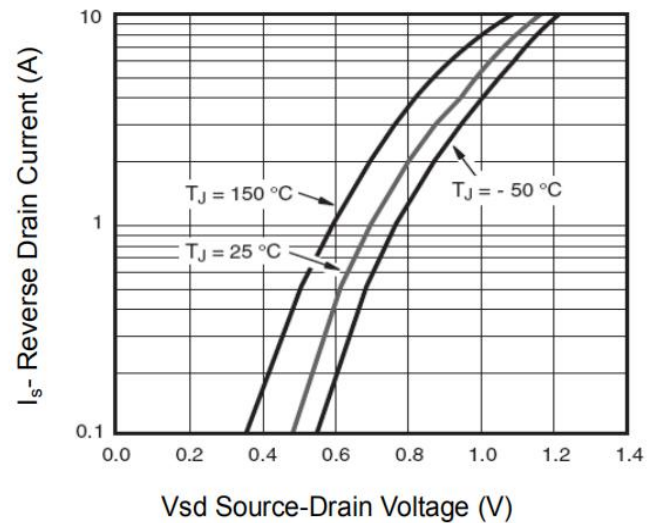

**Figure 12 Source-Drain Diode Forward**

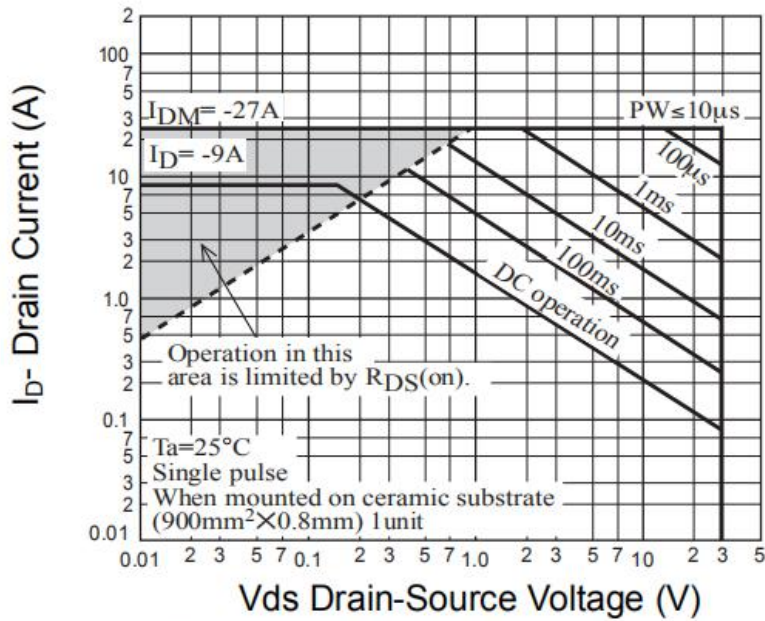

Figure 13 Safe Operation Area

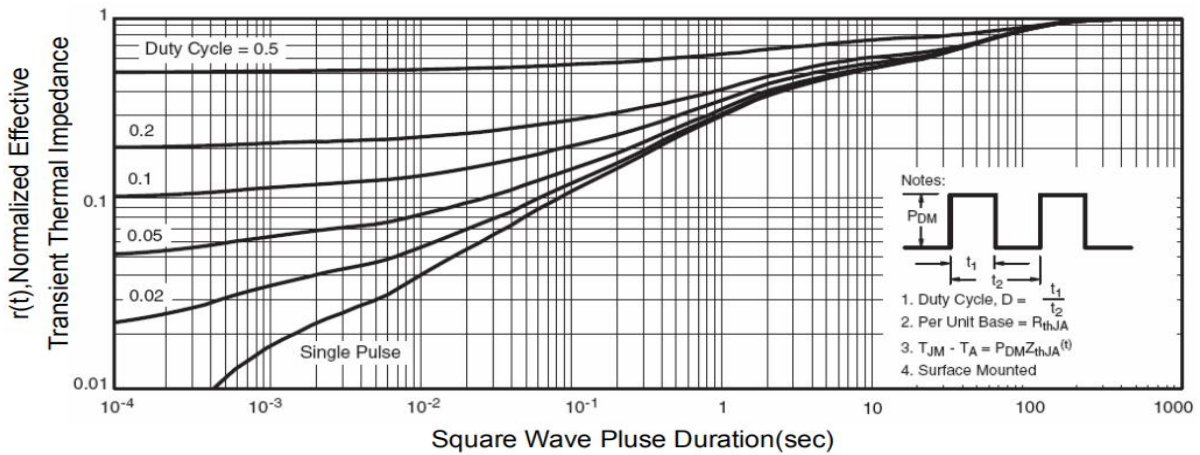
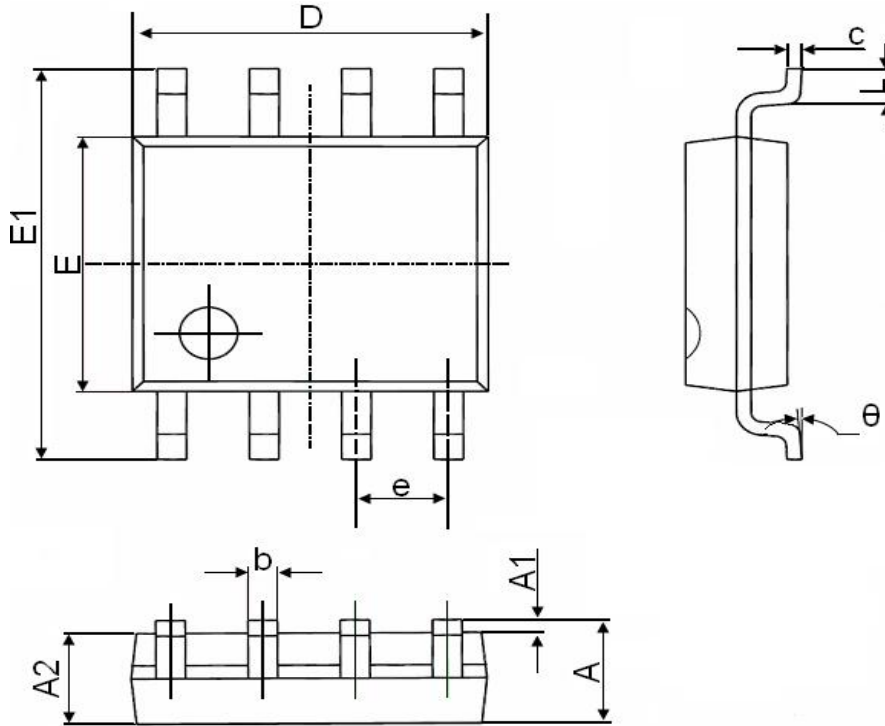

Figure 14 Normalized Maximum Transient Thermal Impedance



SOP-8 Package Information



Symbol	Dimensions In Millimeters		Dimensions In Inches	
	Min.	Max.	Min.	Max.
A	1.350	1.750	0.053	0.069
A1	0.100	0.250	0.004	0.010
A2	1.350	1.550	0.053	0.061
b	0.330	0.510	0.013	0.020
c	0.170	0.250	0.006	0.010
D	4.700	5.100	0.185	0.200
E	3.800	4.000	0.150	0.157
E1	5.800	6.200	0.228	0.244
e	1.270(BSC)		0.050(BSC)	
L	0.400	1.270	0.016	0.050
θ	0°	8°	0°	8°