



**P-Channel Enhancement Mode Power MOSFET**

**Description**

The PE30P65K uses advanced trench technology to provide excellent  $R_{DS(ON)}$  and low gate charge. It can be used in a wide variety of applications.

**General Features**

- $V_{DS} = -30V$ ,  $I_D = -65A$

$R_{DS(ON)} < 5.2m\Omega @ V_{GS}=-20V$

$R_{DS(ON)} < 6m\Omega @ V_{GS}=-10V$

$R_{DS(ON)} < 8m\Omega @ V_{GS}=-4.5V$

- High Power and current handling capability
- Lead free product is acquired
- Surface Mount Package

**Application**

- PWM applications
- Load switch
- Power management
- Battery Protection

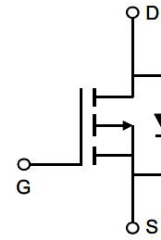

Schematic diagram

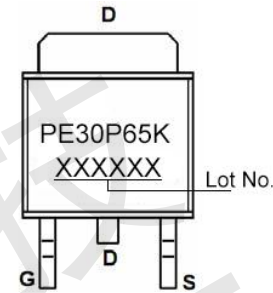

Marking and pin assignment

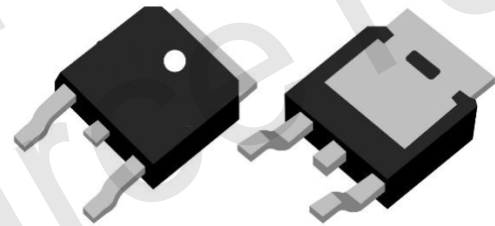

TO-252-2L

**Absolute Maximum Ratings (TC=25°C unless otherwise noted)**

Parameter	Symbol	Rating	Unit
Drain-Source Voltage	$V_{DS}$	-30	V
Gate-Source Voltage	$V_{GS}$	$\pm 25$	V
Drain Current-Continuous	$I_D$	-65	A
Drain Current-Continuous (TC=100°C)	$I_D$	-51	A
Pulsed Drain Current (Note 1)	$I_{DM}$	-180	A
Maximum Power Dissipation	$P_D$	90	W
Avalanche Current	$I_{AS}$	64	A
Avalanche Energy (L=0.1mH)	$E_{AS}$	205	mJ
Operating Junction and Storage Temperature Range	$T_J, T_{STG}$	-55 To 175	°C

**Thermal Characteristic**

Thermal Resistance, Junction-to-Case (Note 2)	$R_{\theta JC}$	1.6	°C/W
---	-----------------	-----	------



**Electrical Characteristics (TC=25°C unless otherwise noted)**

Parameter	Symbol	Condition	Min	Typ	Max	Unit
<b>Off Characteristics</b>						
Drain-Source Breakdown Voltage	$BV_{DSS}$	$V_{GS}=0V, I_D=-250\mu A$	-30	-	-	V
Zero Gate Voltage Drain Current	$I_{DSS}$	$V_{DS}=-30V, V_{GS}=0V$	-	-	1	$\mu A$
Gate-Body Leakage Current	$I_{GSS}$	$V_{GS}=\pm 20V, V_{DS}=0V$	-	-	$\pm 100$	nA
<b>On Characteristics (Note 3)</b>						
Gate Threshold Voltage	$V_{GS(th)}$	$V_{DS}=V_{GS}, I_D=-250\mu A$	-1	-1.5	-2.2	V
Drain-Source On-State Resistance	$R_{DS(on)}$	$V_{GS}=-20V, I_D=-20A$	-	4.3	5.2	m $\Omega$
		$V_{GS}=-10V, I_D=-20A$	-	4.7	6	m $\Omega$
		$V_{GS}=-4.5V, I_D=-10A$	-	6.4	8	m $\Omega$
Forward Transconductance	$g_{FS}$	$V_{DS}=-5V, I_D=-20A$	-	45	-	S
<b>Dynamic Characteristics (Note 4)</b>						
Input Capacitance	$C_{iss}$	$V_{DS}=-15V, V_{GS}=0V,$ $F=200KHz$	-	4910	-	pF
Output Capacitance	$C_{oss}$		-	760	-	pF
Reverse Transfer Capacitance (Note 4)	$C_{rss}$		-	430	-	pF
Gate Resistance	$R_g$	$V_{DS}=0V, V_{GS}=0V, F=1.0MHz$	-	15	-	$\Omega$
<b>Switching Characteristics</b>						
Turn-on Delay Time	$t_{d(on)}$	$V_{DD}=-15V, R_L=1\Omega,$ $V_{GS}=-10V, R_G=3\Omega$	-	17	-	nS
Turn-on Rise Time	$t_r$		-	12	-	nS
Turn-Off Delay Time	$t_{d(off)}$		-	40	-	nS
Turn-Off Fall Time	$t_f$		-	21	-	nS
Total Gate Charge	$Q_g$	$V_{DS}=-15V, I_D=-20A,$ $V_{GS}=-10V$	-	58	-	nC
Gate-Source Charge	$Q_{gs}$		-	12	-	nC
Gate-Drain Charge	$Q_{gd}$		-	14	-	nC
<b>Drain-Source Diode Characteristics</b>						
Diode Forward Voltage (Note 3)	$V_{SD}$	$V_{GS}=0V, I_S=-1A$	-	-	-1.2	V
Max Body Diode Continuous Current (Note 5)	$I_S$		-	-	-65	A

**Notes:**

1. Repetitive Rating: Pulse width limited by maximum junction temperature.
2. Surface Mounted on FR4 Board,  $t \leq 10$  sec.
3. Pulse Test: Pulse Width  $\leq 300\mu s$ , Duty Cycle  $\leq 2\%$ .
4. Guaranteed by design, not subject to product.
5. Package Limited.



Typical Electrical and Thermal Characteristics

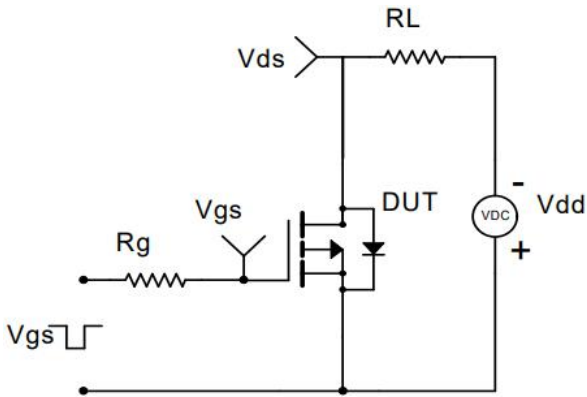

Figure 1 Switching Test Circuit

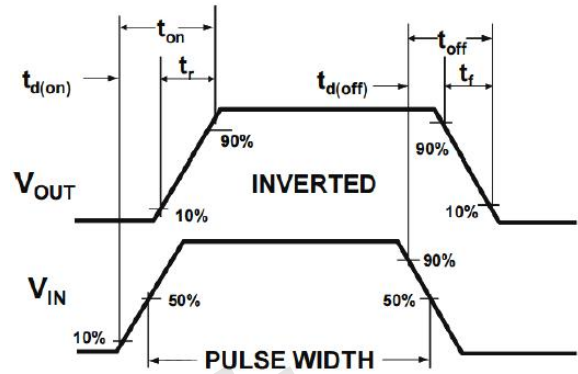

Figure 2 Switching Waveform

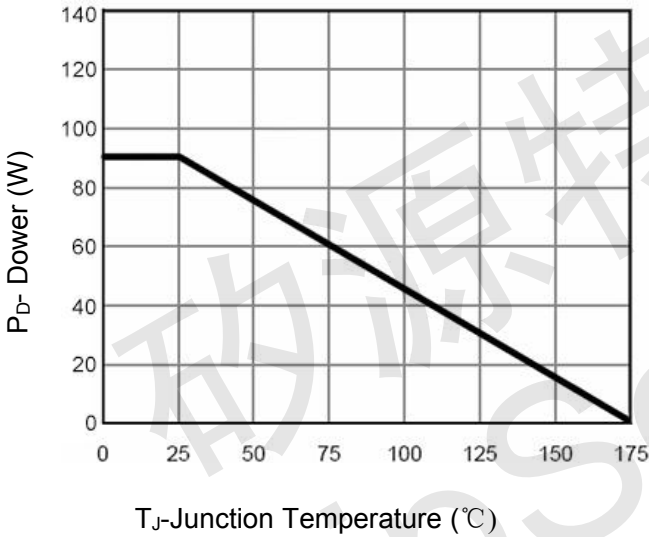

Figure 3 Power De-rating

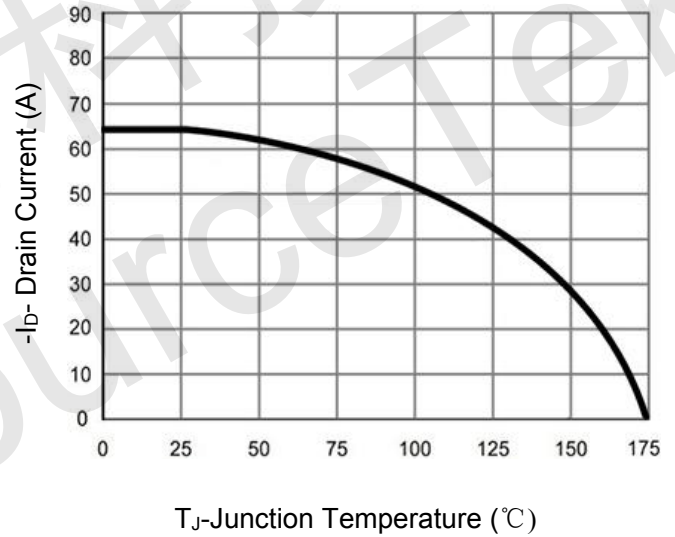

Figure 4 Drain Current

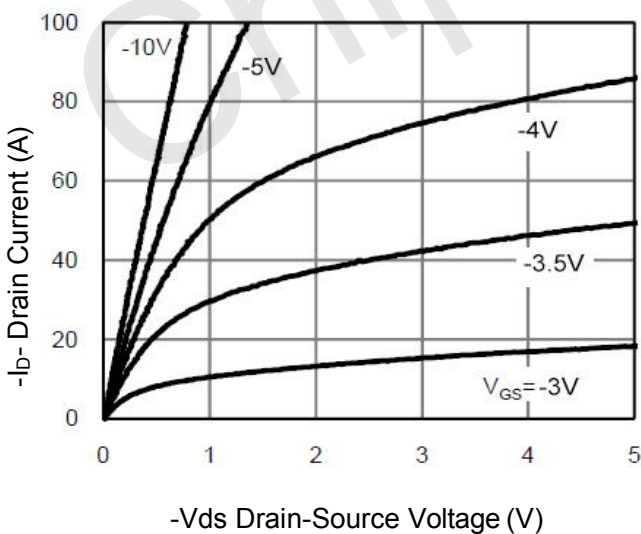

Figure 5 Output Characteristics

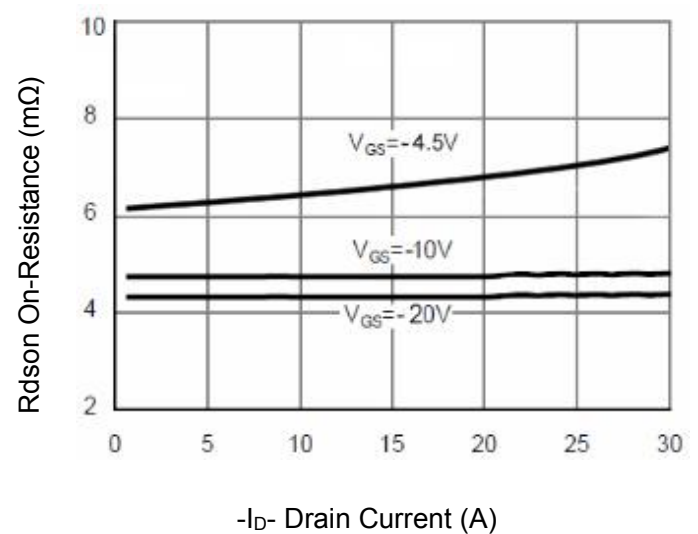

Figure 6 Rdson vs Drain Current

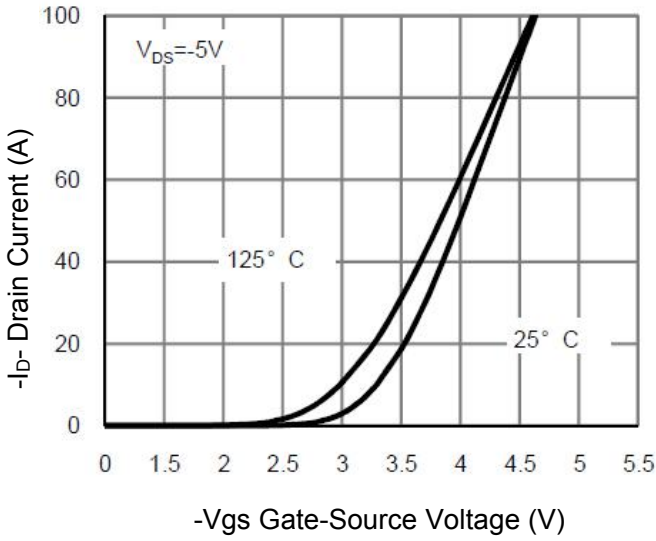

Figure 7 Transfer Characteristics

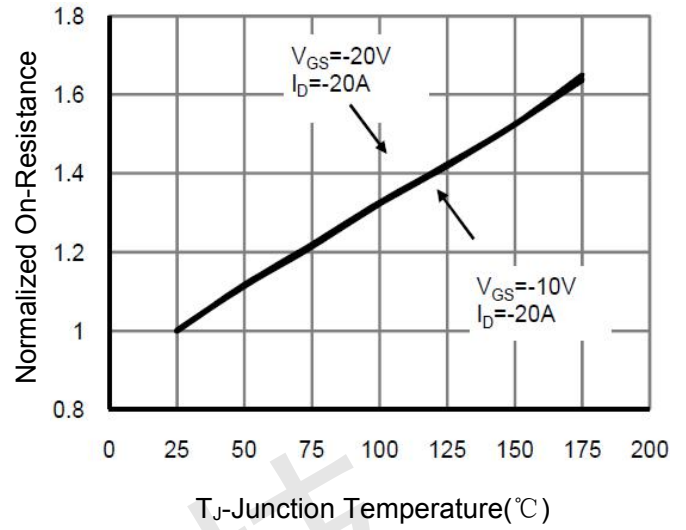

Figure 8 Rdson vs Junction Temperature

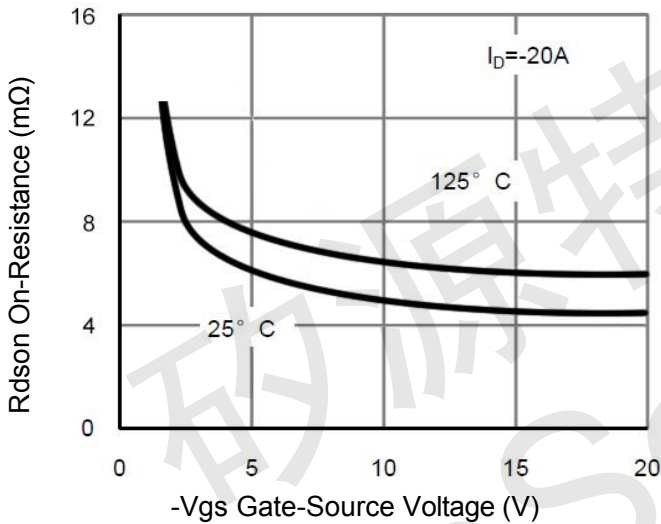

Figure 9 Rdson vs Vgs

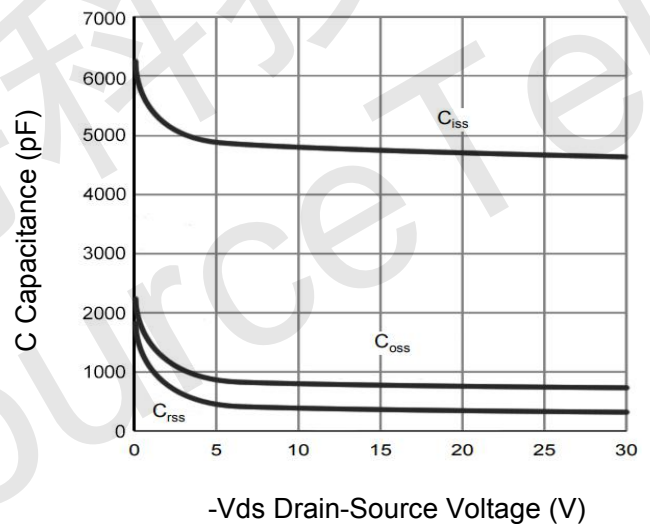

Figure 10 Capacitance vs Vds

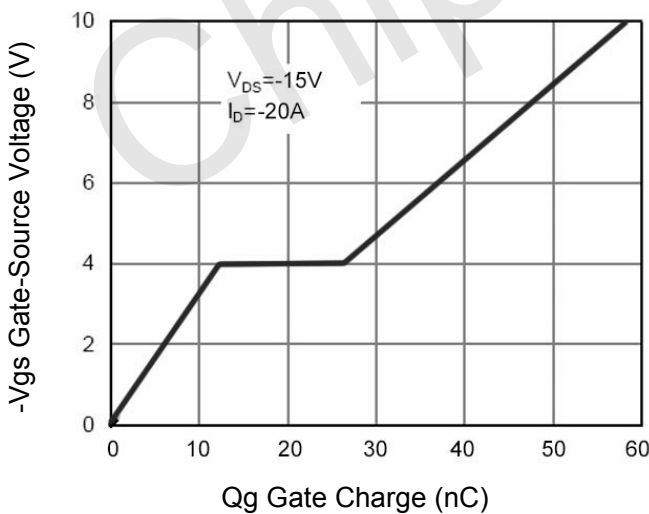

Figure 11 Gate Charge

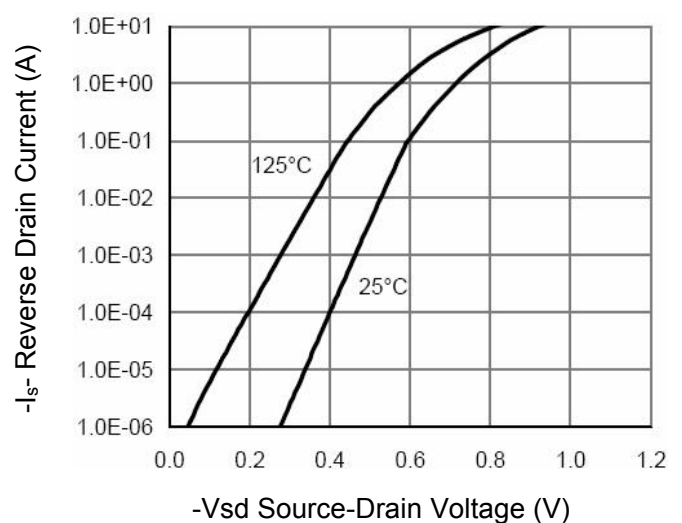

Figure 12 Source- Drain Diode Forward



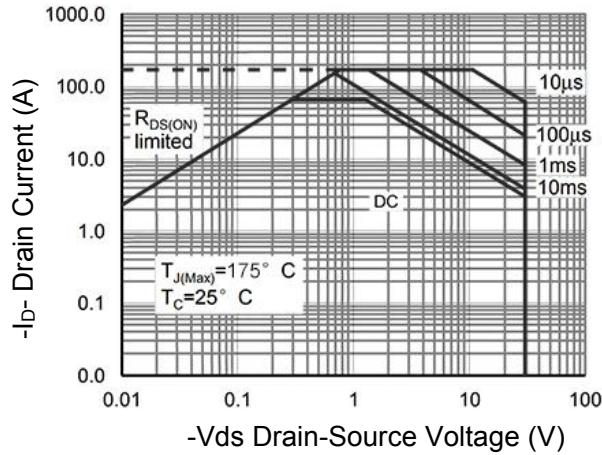

Figure 13 Safe Operation Area

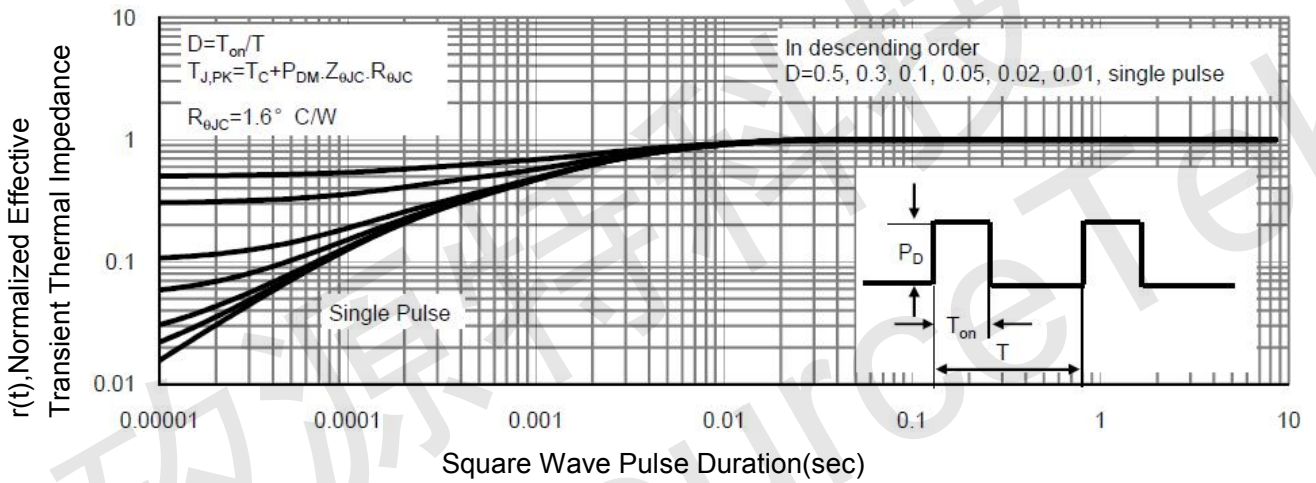
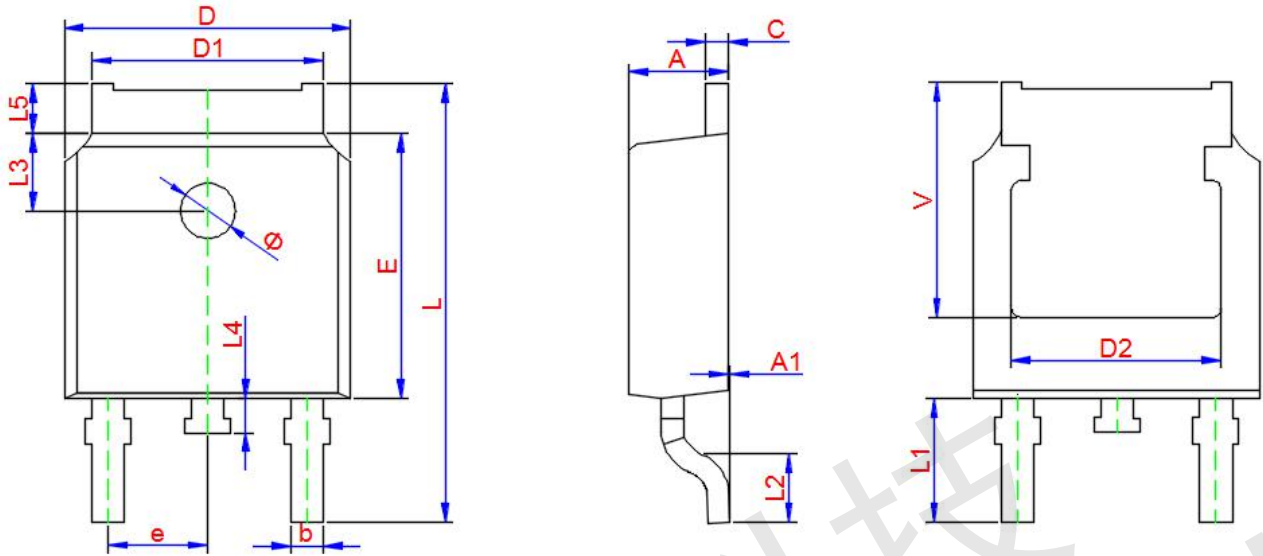

Figure 14 Normalized Maximum Transient Thermal Impedance



TO-252-2L Package Information



Symbol	Dimensions In Millimeters		
	Min.	Typ.	Max.
A	2.200	2.300	2.400
A1	0.000	--	0.127
D	6.500	6.600	6.700
D1	5.100	5.330	5.460
C	0.450	0.500	0.600
D2	4.830 TYP.		
E	6.000	6.100	6.200
e	2.186	2.286	2.386
L	9.800	10.100	10.400
L1	2.900 TYP.		
L2	1.400	1.500	1.600
L3	1.800 TYP.		
L4	0.600	0.800	1.000
L5	0.900	--	1.250
Φ	1.100.	--	1.300
θ	0°	--	8°
V	5.350		