



5W 单通道 F 类音频功率放大器

描述

MIX2018A是一款高效率、无滤波器5W单声道 F类音频放大器。超低的EMI非常适合应用于带FM功能的便携式设备中。

MIX2018A的单端输入架构和极高的PSRR有效地提高了MIX2018A对RF噪声的抑制能力。无需滤波器的PWM调制结构及增益内置方式减少了外部元件、PCB面积和系统成本,并简化了设计。高达90%的效率,快速地启动时间和纤小的封装尺寸使得MIX2018A成为便携式音频产品的最佳选择。

MIX2018A具有关断功能,极大的延长系统的待机时间。过热保护功能增强系统的可靠性。POP声抑制功能改善了系统的听觉感受,同时简化系统调试

MIX2018A提供带散热片的ESOP8封装

特性

- 独有的无FM干扰类架构
- D类输出功率:
-5.0W (VDD=5.0V, RL =2Ω, THD+N=10%)
- F类输出功率:
-4.9W (VDD=5.0V, RL =2Ω, THD+N=10%)
- 低失真和低噪声
- 开机POP声抑制功能
- 关机电流小于1uA
- 过热保护功能

应用

- 扩音器
- 便携式音箱 / 插卡音箱
- 插卡音箱 / USB音箱

典型应用电路图

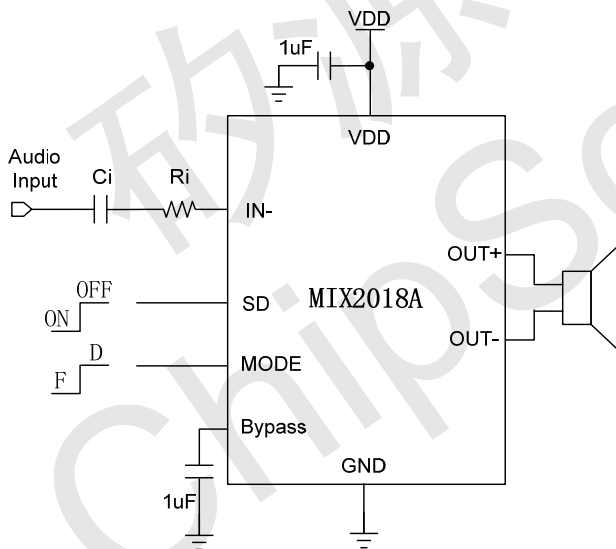

引脚排列

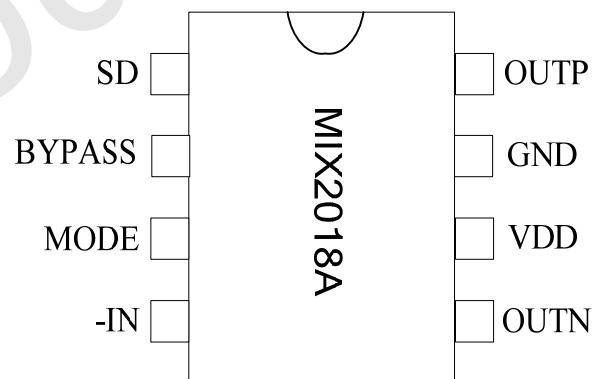



5W 单通道 F 类音频功率放大器

功能框图

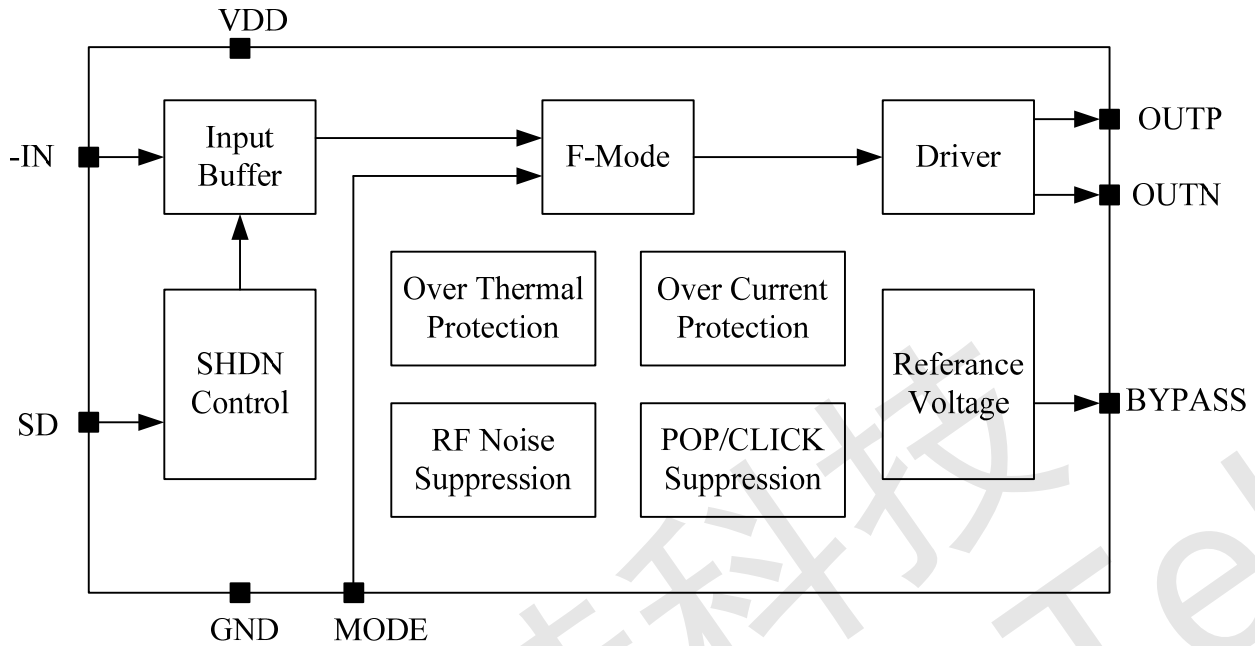

管脚描述

管脚	符号	I/O	描述
1	SD	I	系统关断控制（高电平关机，低电平工作）
2	BYPASS	I	参考电压
3	MODE	I/O	D类，F类选择
4	-IN	I	音频负输入端
5	OUTN	O	音频负输出端
6	VDD		电源
7	GND		地
8	OUTP	O	音频正输出端
9	GND		芯片底部散热片接地



订货信息

料号	封装	表面印字	包装
MIX2018A	ESOP8	MIX2018A XXXXXXX	4000颗/卷

绝对最大额定值

V _{DD}	供电电压	-0.3V to 5.25V
V _I	输入电压	-0.3V to V _{DD} +0.3V
T _A	工作温度	-40°C to 85°C
T _J	结温	-40°C to 125°C
T _{STG}	储存温度	-65°C to 150°C
T _{SLD}	焊接温度	300°C, 5sec

推荐额定值

			MIN	MAX	UNIT
V _{DD}	供电电压	V _{DD}	2.5	5.0	V
V _{IH}	SD高电平	V _{DD} =5.0V	2		V
	MODE高电平		2		
V _{IL}	SD低电平	V _{DD} =5.0V		0.6	
	MODE低电平			0.6	

热阻参数

Parameter	Symbol	Package	MAX	UNIT
热阻 (Junction to Ambient)	θ _{JA}	ESOP8	90	°C/W
热阻 (Junction to Case)	θ _{JC}	ESOP8	11	°C/W



D Mode Electrical Characteristics

(VDD =5V, Gain=22dB, RL =4Ω, T =25°C, unless otherwise noted.)

Symbol	Parameter	Test Conditions	MIN	TYP	MAX	UNIT
V _{IN}	电源电压		2.5	-	5.0	V
P _O	D 类模式输出功率	THD+N=10%,f=1KHZ,RL=4Ω	V _{DD} =5.0V	3.2		W
			V _{DD} =3.6V	1.6		
		THD+N=1%,f=1KHZ,RL=4Ω	V _{DD} =5.0V	2.6		W
			V _{DD} =3.6V	1.3		
		THD+N=10%,f=1KHZ,RL=2Ω	V _{DD} =5.0V	5.0		W
			V _{DD} =3.6V	2.6		
THD+N=1%,f=1KHZ,RL=2Ω	V _{DD} =5.0V	4.1		W		
	V _{DD} =3.6V	2.1				
THD+N	总谐波失真+噪声	V _{DD} =5.0V, P _O =1W, RL=4Ω	f=1KHz	0.12		%
				V _{DD} =3.6V, P _O =1W, RL=4Ω	0.08	
		V _{DD} =5.0V, P _O =2W, RL=2Ω	f=1KHz	0.22		%
				V _{DD} =3.6V, P _O =2W, RL=2Ω	0.2	
G _v	D 类模式增益	R _i = 22K		23		dB
PSRR	电源纹波抑制比	V _{DD} =4.2V ±200mVp-p	f=1KHz	60		dB
SNR	信噪比	V _{DD} =5.0V, V _{o rms} =1V, G _v =22dB	f=1KHz	-83		dB
V _n	残余噪声	V _{DD} =5.0V,Input floating with C _{IN} =0.1μF	A-weighting	70		μV
			No A-weighting	125		
Dyn	动态范围	V _{DD} =5.0V,THD=1%	f=1KHz	-88		dB
η	效率	RL=2Ω, P _O =4W	f=1KHz	82		%
		RL=4Ω, P _O =2.8W		90		
I _q	静态电流	V _{DD} =5.0V	No Load	4		mA
		V _{DD} =3.0V		3		
I _{SD}	关断电流	V _{DD} =2.5V to 5.5V	V _{SD} =0.3V		1	μA
V _{OS}	失调电压	V _{IN} =0V, V _{DD} =5V		10		mV
F _{osc}	工作频率			650		khz
T _{st}	启动时间	Bypass capacitor =1uF		200		mS
OTP	—	No Load, Junction Temperature	V _{DD} =5.0V	180		°C
OTH	—			40		



F Mode Electrical Characteristics

(VDD =5V, Gain=22dB, RL =4Ω, T =25°C, unless otherwise noted.)

Symbol	Parameter	Test Conditions		MIN	TYP	MAX	UNIT
Po	F 类模式输出功率	THD+N=10%,f=1KHZ,RL=4Ω	VDD=5.0V		3.1		W
			VDD=3.6V		1.5		
		THD+N=1%,f=1KHZ,RL=4Ω	VDD=5.0V		2.4		W
			VDD=3.6V		1.2		
		THD+N=10%,f=1KHZ,RL=2Ω	VDD=5.0V		4.9		W
			VDD=3.6V		2.5		
THD+N=1%,f=1KHZ,RL=2Ω	VDD=5.0V		4		W		
	VDD=3.6V		2				
THD+N	总谐波失真+噪声	VDD=5.0V, Po=1W, RL=4Ω	f=1KHz		0.11		%
		VDD=3.6V, Po=1W, RL=4Ω			0.3		
		VDD=5.0V, Po=2W, RL=2Ω	f=1KHz		0.25		%
		VDD=3.6V, Po=2W, RL=2Ω			1.2		
Gv	F 类模式增益		Ri = 22K		23		dB
PSRR	电源纹波抑制比	VDD=4.2V ±200mVp-p	f=1KHz		70		dB
SNR	信噪比	VDD=5.0V, Vorms=1V, GV=22dB	f=1KHz		-83		dB
Vn	残余噪声	VDD=5.0V, Input floating with CIN=0.1μF	A-weighting		70		μV
			No		120		
			A-weighting				
Dyn	动态范围	VDD=5.0V, THD=1%	f=1KHz		-89		dB
Iq	静态电流	VDD=5.0V	No Load		4		mA
		VDD=3.0V			2.8		
IsD	关断电流	VIN=0V, VDD=5V				1	μA
Vos	失调电压	VIN=0V, VDD=5V			10		mV
Tst	启动时间	Bypass capacitor =1uF			200		mS
OTP	—	No Load, Junction Temperature	VDD=5.0V		180		°C
OTH	—				40		



5W 单通道 F 类音频功率放大器

典型特征曲线 (D类工作模式)

(VDD = 5V, Gain=22dB, RL = 4Ω, T = 25°C, unless otherwise noted.)

THD+N vs Output Power

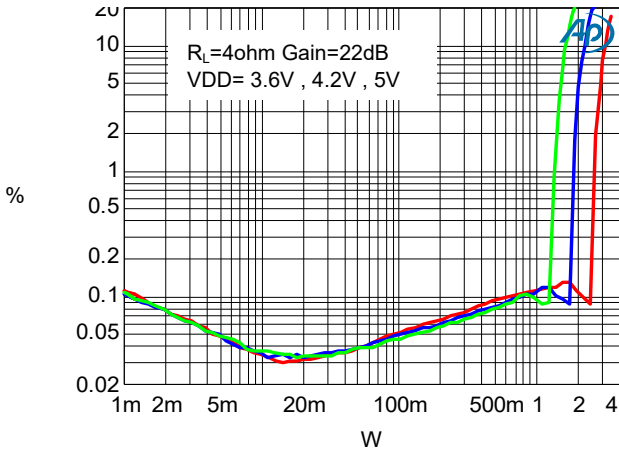

THD+N vs Output Power

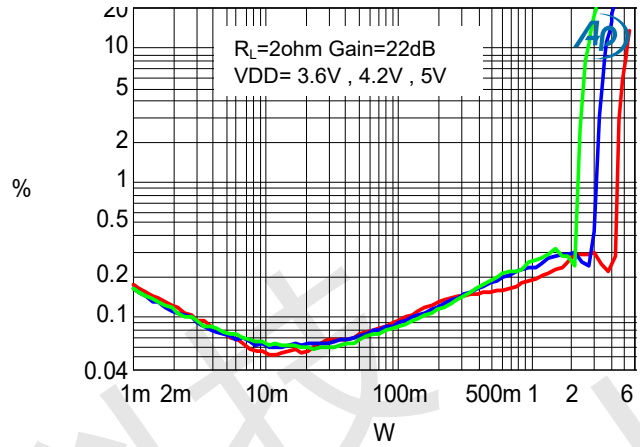

THD+N VS FREQUENCY

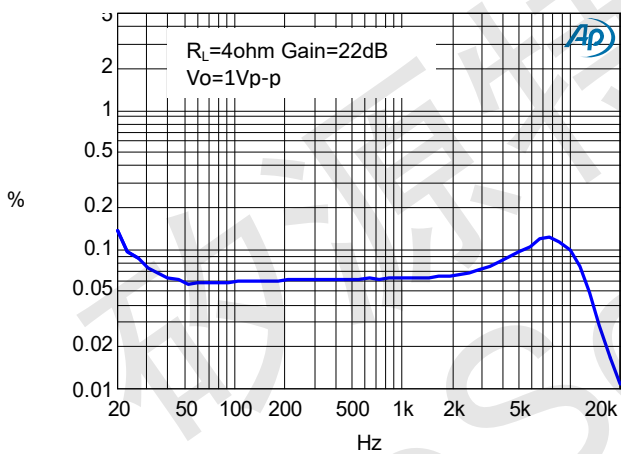

Frequency Response

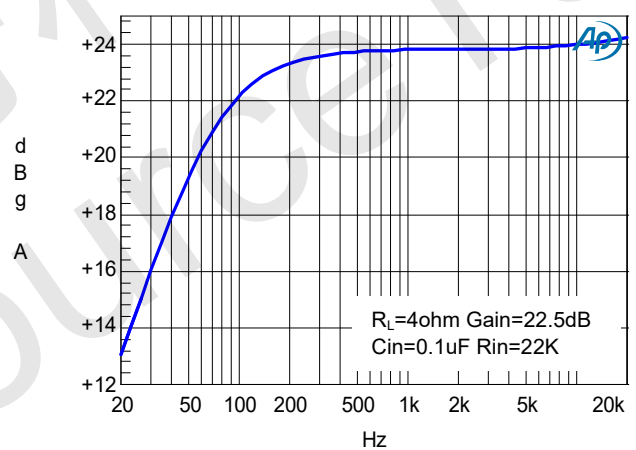

NOISE FLOOR FFT

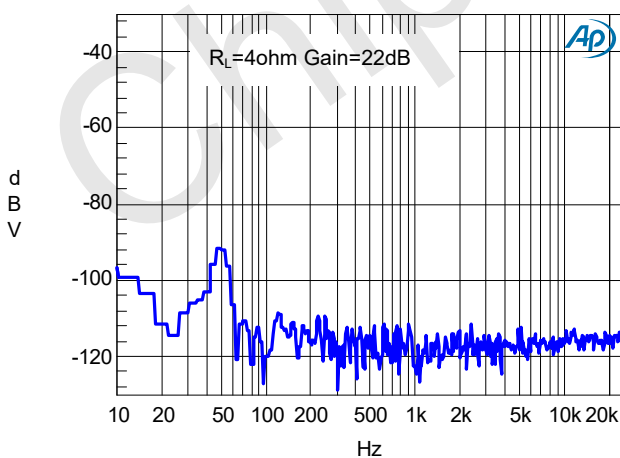



5W 单通道 F 类音频功率放大器

典型特征曲线 (F类工作模式)

(VDD =5V, Gain=22dB, $R_L = 4\Omega$, T =25°C, unless otherwise noted.)

THD+N vs Output Power

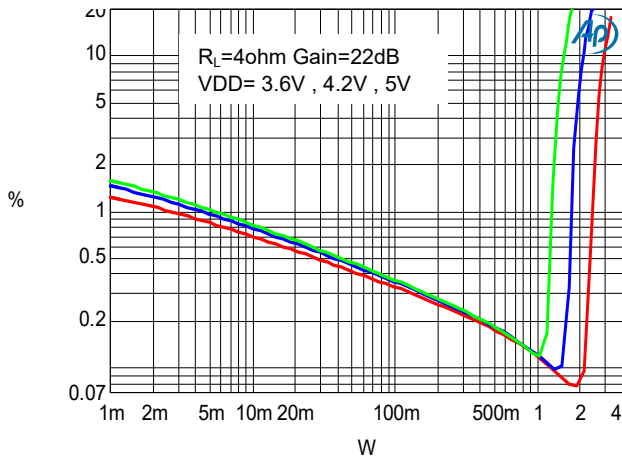

THD+N vs Output Power

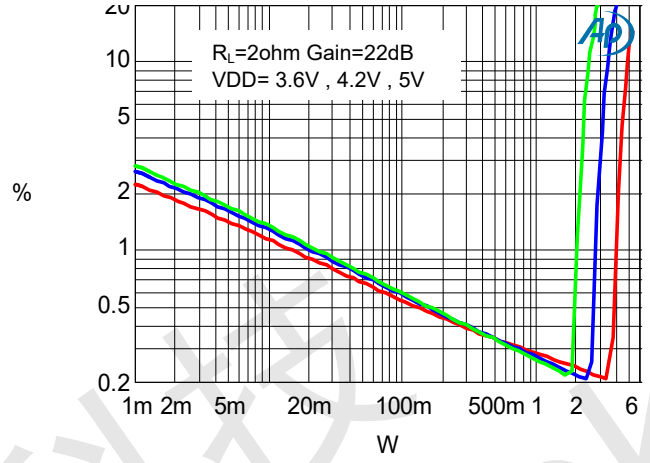

THD+N VS FREQUENCY

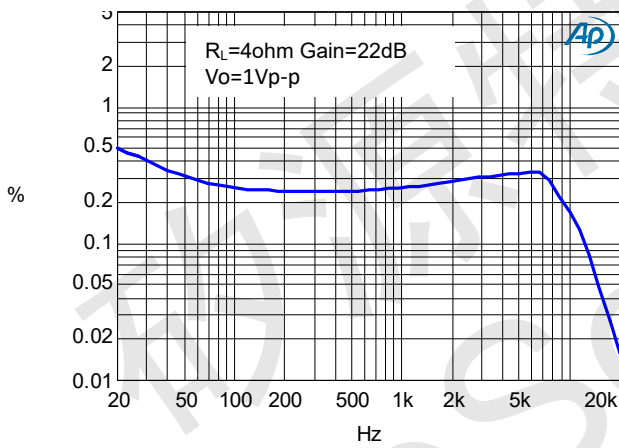

Frequency Response

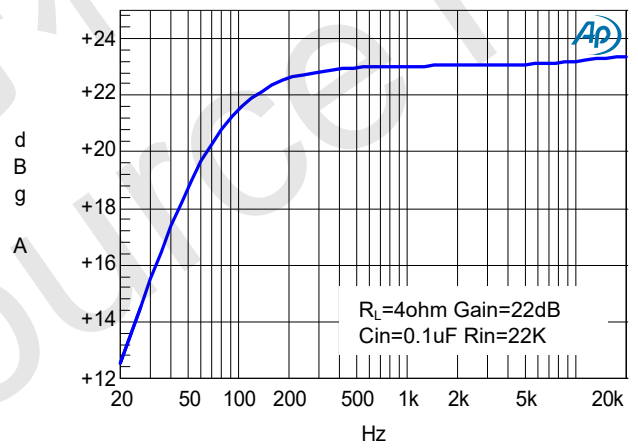

NOISE FLOOR FFT

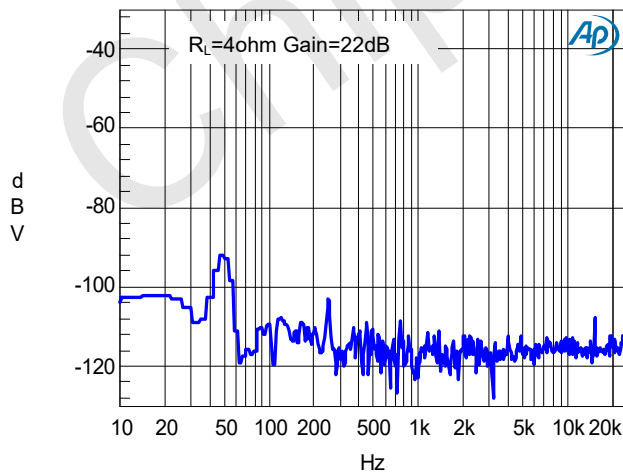



应用信息

模式选择功能

MIX2018A具有两种工作模式，一种为高效率的D类工作模式，另一种为无FM干扰的F类工作模式。通过MODE管脚选择其中的一组，灵活切换。当MODE管脚为逻辑高时，MIX2018A工作在D类模式。当MODE管脚为逻辑低时，MIX2018A工作在F类模式。

输入电阻(Ri)

MIX2018A的增益由音量调节控制的输入电阻(RI)和反馈电阻(RF)控制。

增益计算公式：

$$A_v = 2 \times \frac{R_f}{R_i} \left(\frac{V}{V} \right)$$

其中，输入电阻RI为外部的输入电阻（MIX2018A内部没有集成输入电阻），反馈电阻Rf为150K（反馈电阻为内部固定，不可外部调节）。

输入电容 (Ci)

输入电容与输入电阻构成一个高通滤波器，其截止频率可由下式得出：

$$f_c = \frac{1}{2\pi R_i C_i}$$

Ci的值不仅会影响到电路的低频响应，而且也会影响电路启动和关断时所产生的POP声，输入电容越大，则到达其稳定工作点所需的电荷越多，在同等条件下，小的输入电容所产生的POP声比较小。

偏置电容CBYP

偏置电容是最关键的电容，它与几个重要性能相关，当电路启动时，偏置电容决定了放大器的开启速度，偏置电容同时会影响到电路的噪声、电源抑制比以及开关机的POP声。

为避免启动时的POP声，偏置电压的上升速度应该比输入偏置电压的上升速度慢。

关断工作模式

为了减少在关断模式下的功率损耗，MIX2018A带有关闭放大器偏置的关断电路。当SD引脚为高电平时，放大器被关闭，工作电流达到最小。

过温保护

MIX2018A 带有过温保护电路以防止内部温度超过180°C时器件损坏。在不同器件之间，这个值有25°C的差异。当内部电路超过设置的保护温度时，器件进入关断状态，输出被截止。当温度下降 30°C后，器件重新正常工作。



封装图 (ESOP8)

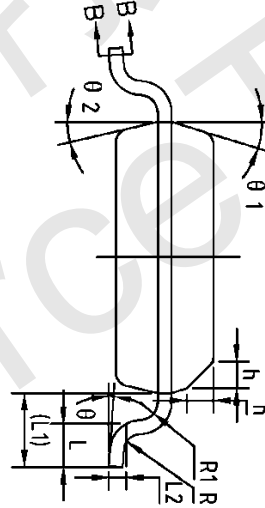
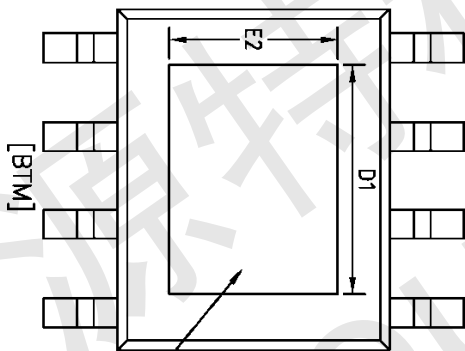
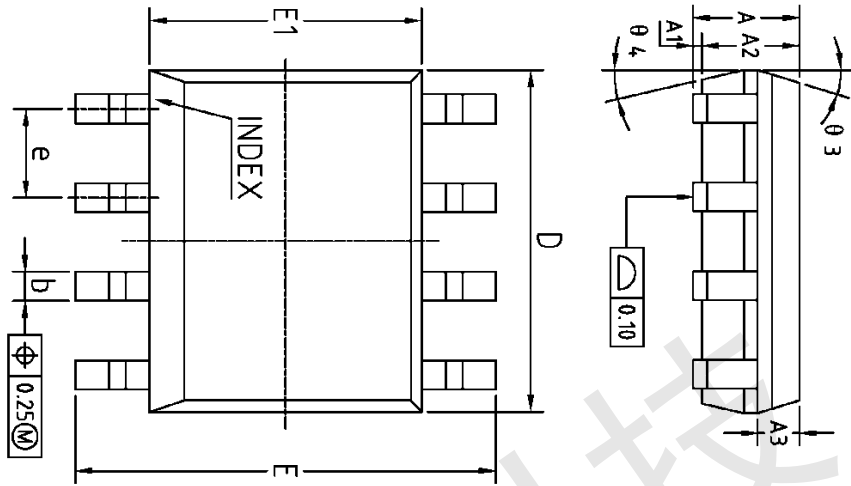

NOTES:
 ALL DIMENSIONS REFER TO JEDEC STANDARD MS-012 AA
 DO NOT INCLUDE MOLD FLASH OR PROTRUSIONS.

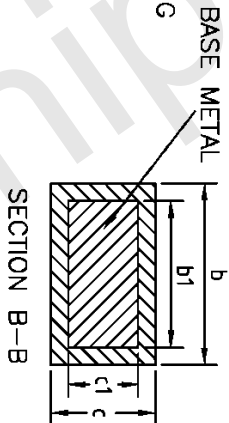

COMMON DIMENSIONS (UNITS OF MEASURE=MILLIMETER)			
SYMBOL	MIN	NOM	MAX
A	1.35	1.55	1.75
A1	0	0.10	0.15
A2	1.25	1.40	1.65
A3	0.50	0.60	0.70
b	0.38	-	0.51
b1	0.37	0.42	0.47
c	0.17	-	0.25
c1	0.17	0.20	0.23
D	4.80	4.90	5.00
D1	3.10	3.30	3.50
E	5.80	6.00	6.20
E1	3.80	3.90	4.00
E2	2.20	2.40	2.60
e	1.27BSC		
L	0.45	0.60	0.80
L1	1.04REF		
L2	0.25BSC		
R	0.07	-	-
R1	0.07	-	-
h	0.30	0.40	0.50
theta	0°	-	8°
theta 1	15°	17°	19°
theta 2	11°	13°	15°
theta 3	15°	17°	19°
theta 4	11°	13°	15°