



N-Channel Enhancement Mode Power MOSFET **MX0205**

DESCRIPTION

The MX0205 uses advanced trench technology to provide excellent $R_{DS(ON)}$, low gate charge and operation with gate voltages as low as 2.5V. This device is suitable for use as a Battery protection or in other Switching application.

GENERAL FEATURES

- $V_{DS} = 60V, I_D = 2.8A$
 $R_{DS(ON)} < 100m\Omega @ V_{GS} = 10V$
 $R_{DS(ON)} < 115m\Omega @ V_{GS} = 4.5V$
- High Power and current handing capability
- Lead free product is acquired
- Surface Mount Package

APPLICATION

- Battery Switch
- DC/DC Converter

PINOUT

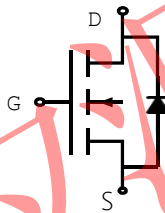

Schematic diagram

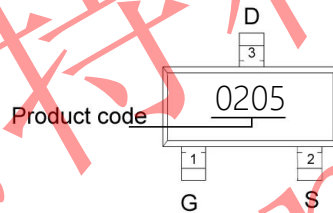

Marking and pin Assignment



SOT-23 -3L top view

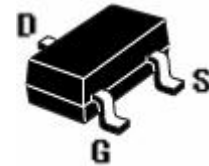
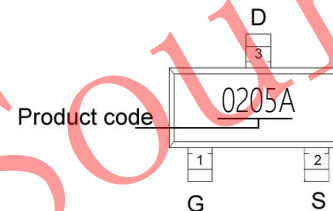

SOT-23 top view

ABSOLUTE MAXIMUM RATINGS ($T_A = 25^\circ C$ unless otherwise noted)

Parameter	Symbol	Limit	Unit
Drain-Source Voltage	V_{DS}	60	V
Gate-Source Voltage	V_{GS}	± 20	V
Drain Current-Continuous	I_D	2.8	A
Drain Current-Pulsed (Note 1)	I_{DM}	10	A
Maximum Power Dissipation	P_D	1.7	W
Operating Junction and Storage Temperature Range	T_J, T_{STG}	-55 To 150	$^\circ C$
Thermal Resistance, Junction-to-Ambient (Note 2)	$R_{\theta JA}$	73.5	$^\circ C/W$

Note 1. Repetitive Rating: Pulse width limited by maximum junction temperature.

Note 2. Surface Mounted on FR4 Board, $t \leq 10$ sec.

TEL: +86-0755-27595155 27595165

FAX: +86-0755-27594792

WEB: [Http://www.ChipSourceTek.com](http://www.ChipSourceTek.com)

E-mail: Tony.Wang@ChipSourceTek.com InFo@ChipSourceTek.com



N-Channel Enhancement Mode Power MOSFET **MX0205**



ELECTRICAL CHARACTERISTICS(TA=25°C unless otherwise noted)

Parameter	Symbol	Condition	Min	Typ	Max	Unit
-----------	--------	-----------	-----	-----	-----	------

Off Characteristics

Drain-Source Breakdown Voltage	BV_{DSS}	$V_{GS}=0V, I_D=250\mu A$	60	-	-	V
Zero Gate Voltage Drain Current	I_{DSS}	$V_{DS}=60V, V_{GS}=0V$	-	-	1	μA
Gate-Body Leakage Current	I_{GSS}	$V_{GS}=\pm 20V, V_{DS}=0V$	-	-	± 100	nA

On Characteristics (Note 3)

Gate Threshold Voltage	$V_{GS(th)}$	$V_{DS}=V_{GS}, I_D=250\mu A$	0.5	1.0	1.5	V
Drain-Source On-State Resistance	$R_{DS(on)}$	$V_{GS}=10V, I_D=2.8A$	-	87	100	m Ω
		$V_{GS}=4.5V, I_D=2.8A$	-	95	115	m Ω
		$V_{GS}=2.5V, I_D=2A$	-	130	150	m Ω

Dynamic Characteristics(Note4)

Input Capacitance	C_{iss}	$V_{DS}=30V, V_{GS}=0V, F=1.0MHz$	-	247	-	PF
Output Capacitance	C_{oss}		-	34	-	PF
Reverse Transfer Capacitance	C_{rss}		-	19.5	-	PF

Switching Characteristics(Note 4)

Turn-on Delay Time	$t_{d(on)}$	$V_{DD}=30V, I_D=1.5A, V_{GS}=10V, R_{GEN}=1\Omega$	-	6	-	nS
Turn-on Rise Time	t_r		-	15	-	nS
Turn-Off Delay Time	$t_{d(off)}$		-	15	-	nS
Turn-Off Fall Time	t_f		-	10	-	nS
Total Gate Charge	Q_g	$V_{DS}=30V, I_D=2.5A, V_{GS}=4.5V$	-	6	-	nC
Gate-Source Charge	Q_{gs}		-	1	-	nC
Gate-Drain Charge	Q_{gd}		-	1.3	-	nC

Drain-Source Diode Characteristics

Diode Forward Voltage (Note 3)	V_{SD}	$V_{GS}=0V, I_S=2.5A$	-	-	1.2	V
Diode Forward Current (Note 2)	I_S		-	-	3	A

Note 2. Surface Mounted on FR4 Board, $t \leq 10$ sec.

Note 3. Pulse Test: Pulse Width $\leq 300\mu s$, Duty Cycle $\leq 2\%$.

Note 4. Guaranteed by design, not subject to production



N-Channel Enhancement Mode Power MOSFET **MX0205**

TYPICAL ELECTRICAL AND THERMAL CHARACTERISTICS

Figure 1. Switching Test Circuit

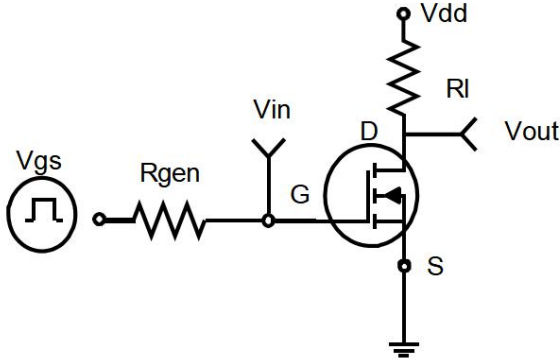

Figure 2. Switching Waveforms

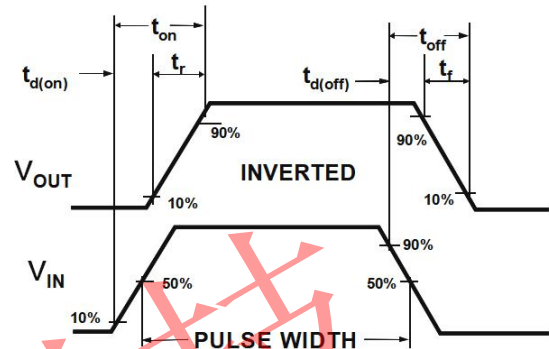

Figure 3. Power Dissipation

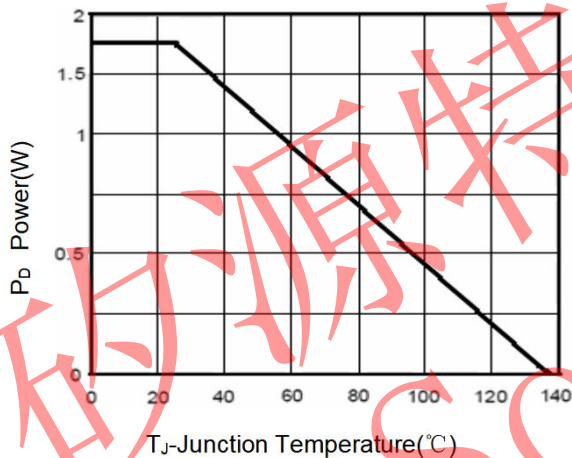

Figure 4. Drain Current

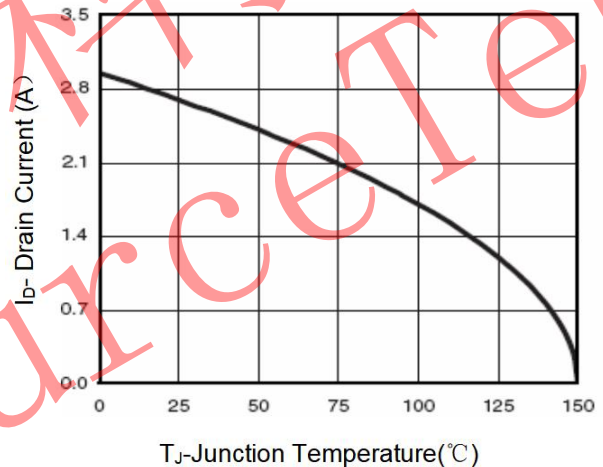

Figure 5. Output Characteristics

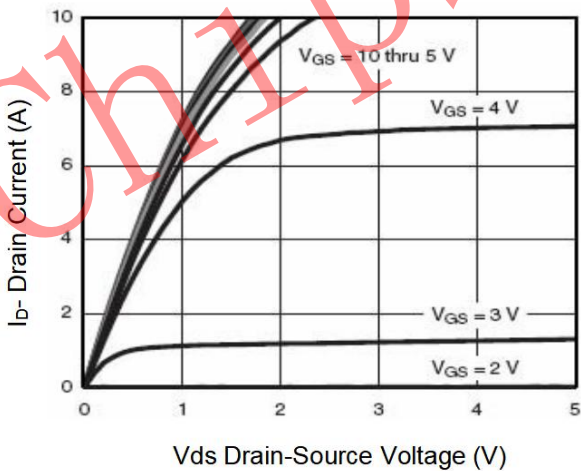
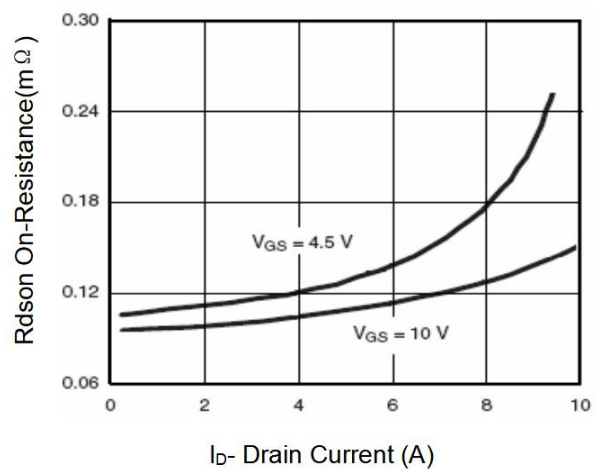

Figure 6. Drain-Source On-Resistance





N-Channel Enhancement Mode Power MOSFET **MX0205**



TYPICAL ELECTRICAL AND THERMAL CHARACTERISTICS

Figure 7. Transfer Characteristics

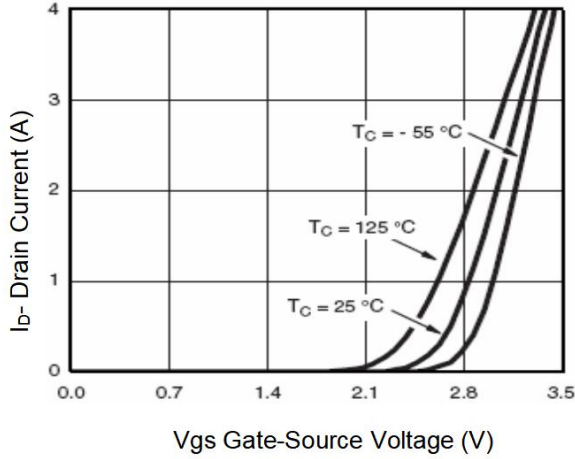

Figure 8. Drain-Source On-Resistance

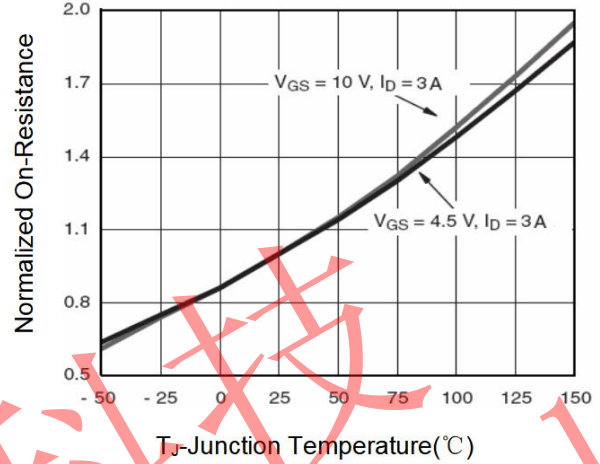

Figure 9. R_{dson} vs V_{GS}

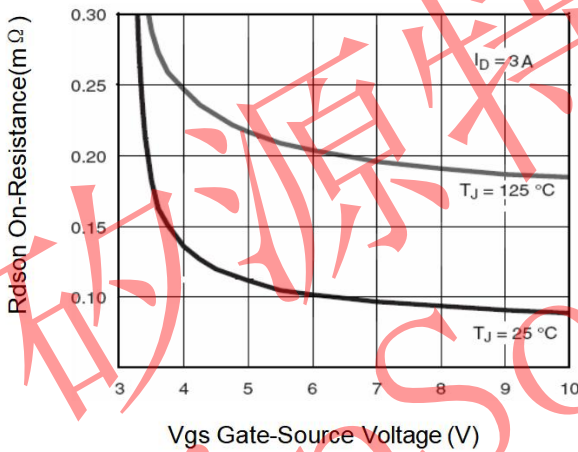

Figure 10. Capacitance vs V_{DS}

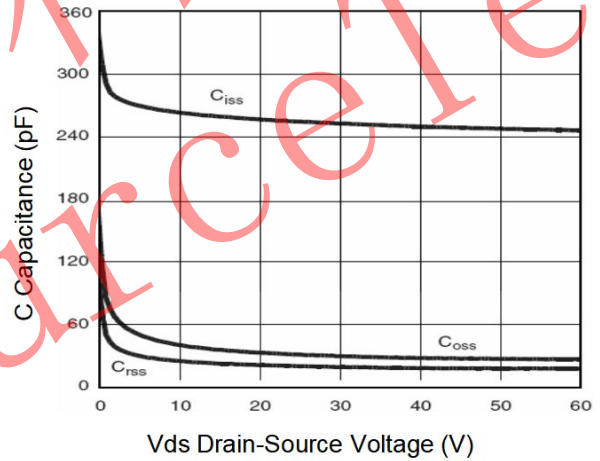

Figure 11. Gate Charge

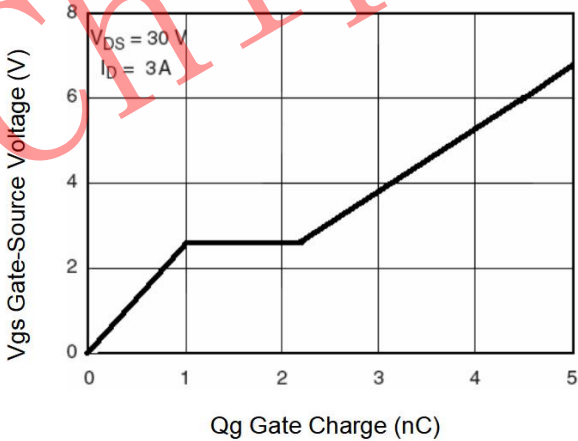
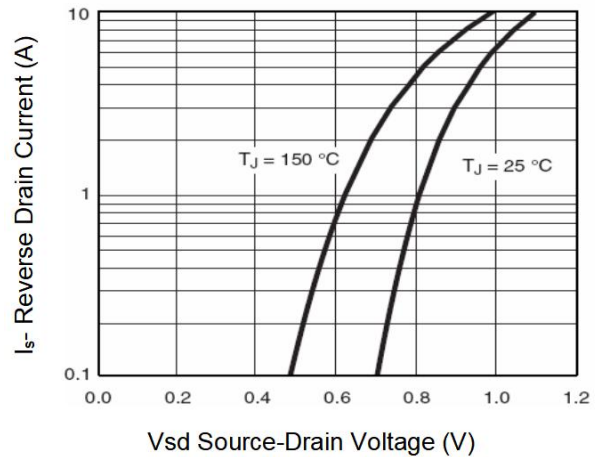

Figure 12. Source- Drain Diode Forward





TYPICAL ELECTRICAL AND THERMAL CHARACTERISTICS

Figure 13. Safe Operation Area

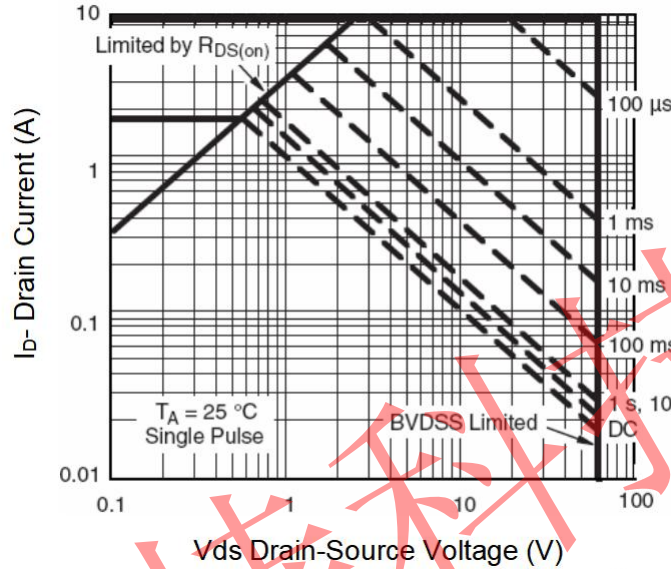
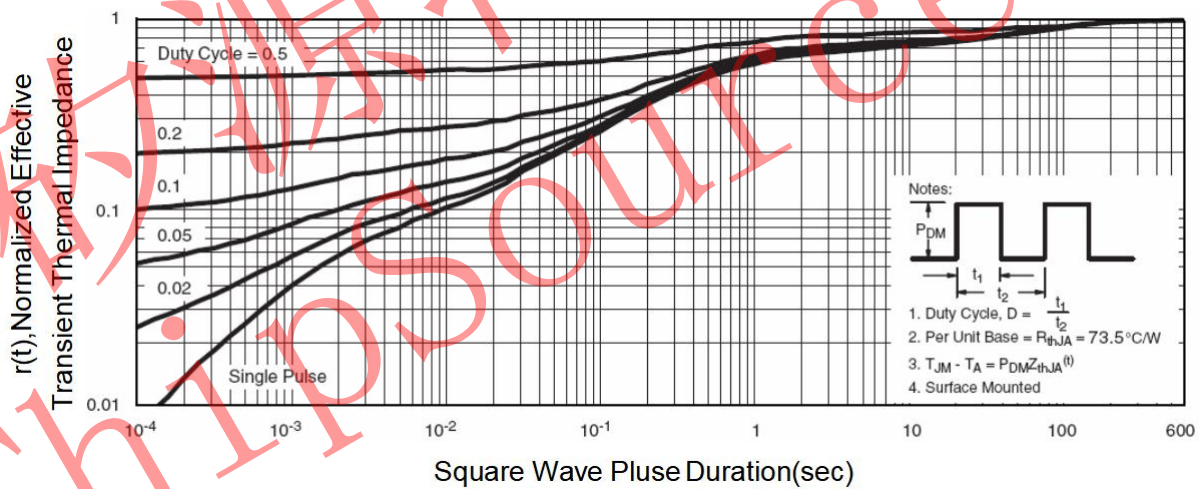

Figure 14. Normalized Maximum Transient Thermal Impedance





N-Channel Enhancement Mode Power MOSFET **MX0205**

PACKAGE INFORMATION

SOT-23-3L

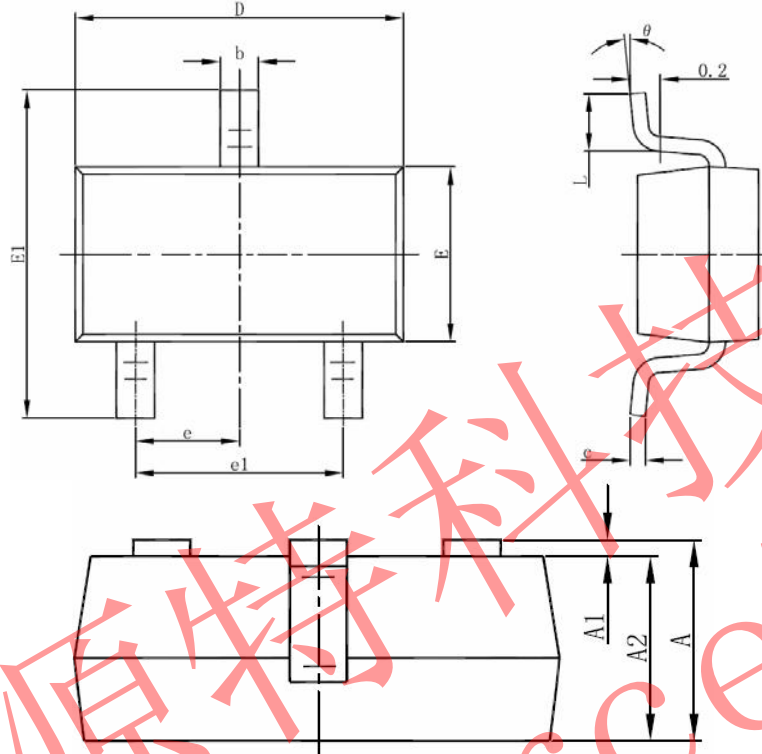

Symbol	Dimensions in Millimeters		Dimensions in Inches	
	Min	Max	Min	Min
A	1.050	1.250	0.041	0.049
A1	0.000	0.100	0.000	0.004
A2	1.050	1.150	0.041	0.045
b	0.300	0.500	0.012	0.020
c	0.100	0.200	0.004	0.008
D	2.820	3.020	0.111	0.119
E	1.500	1.700	0.059	0.067
E1	2.650	2.950	0.104	0.116
e	0.950(BSC)		0.037(BSC)	
e1	1.800	2.000	0.071	0.079
L	0.300	0.600	0.012	0.024
θ	0°	8°	0°	8°



N-Channel Enhancement Mode Power MOSFET **MX0205**

PACKAGE INFORMATION

SOT-23

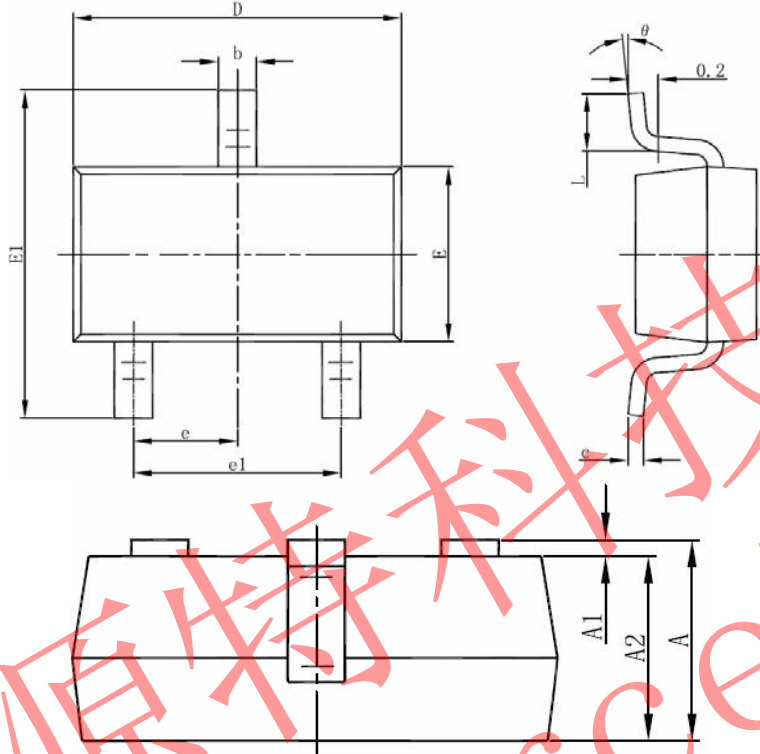

Symbol	Dimensions in Millimeters		Dimensions in Inches	
	Min	Max	Min	Min
A	0.900	1.150	0.035	0.045
A1	0.000	0.100	0.000	0.004
A2	0.900	1.050	0.035	0.041
b	0.300	0.500	0.012	0.020
c	0.080	0.150	0.003	0.006
D	2.800	3.000	0.110	0.118
E	1.200	1.400	0.047	0.055
E1	2.250	2.550	0.089	0.100
e	0.950TYP		0.037TYP	
e1	1.800	2.000	0.071	0.079
L	0.300	0.500	0.012	0.020
θ	0°	8°	0°	8°